



**ROHDE & SCHWARZ**

Test and Measurement  
Division

## **Operating Manual**

### **Signal Generator**

**AM / FM /  $\phi$ M**

#### **SMY01**

9 kHz - 1040 MHz  
1062.5502.11

#### **SMY02**

9 kHz - 2080 MHz  
1062.5502.12

#### **SMY43**

9 kHz - 2080 MHz  
1062.5502.43

Printed in the Federal  
Republic of Germany

## **Tabbed Divider Overview**

**Contents**

**Data Sheet**

**Safety Instructions**

**Certificate of quality**

**EC Certificate of Conformity**

**List of R & S Representatives**

**Tabbed Divider**

<b>1</b>	<b>Chapter 1: Preparation for Use</b>
<b>2</b>	<b>Chapter 2: Manual Operation</b>
<b>3</b>	<b>Chapter 3: Remote Control</b>
<b>4</b>	<b>Chapter 4: Maintenance</b>
<b>5</b>	<b>Chapter 5: Performance Test</b>
<b>6</b>	<b>Index</b>

# Contents

	Page
<b>1 Preparation for Use</b>	
1.1 Putting into Operation.....	1.1
1.2 Power Supply/Power Fuses.....	1.1
1.3 Mounting into a 19" Rack .....	1.1
1.4 Option SMY-B1 .....	1.2
1.5 Option SMY-B40 .....	1.3
<b>2 Manual Operation</b>	
2.1 Front and Rear Views.....	2.2
2.2 Pattern Setting for First Users .....	2.4
2.3 Basic Operation .....	2.4
2.4 Power-on Status .....	2.9
2.5 Internal/External Reference Frequency .....	2.9
2.6 Frequency (RF) .....	2.10
2.7 LEVEL .....	2.10
2.8 Non-Interrupting Level Setting.....	2.11
2.9 Level Control Without Function.....	2.11
2.10 Level EMF.....	2.12
2.11 Internal AF Modulation Frequency .....	2.12
2.12 Modulation, AM .....	2.13
2.13 Pulse Modulation.....	2.15
2.14 Modulation, FM .....	2.15
2.15 Modulation, $\phi$ M .....	2.17
2.16 Modulation, External Source.....	2.18
2.17 Modulation, Two-tone .....	2.18
2.18 Variation, Rotary Knob.....	2.19
2.19 Sweep .....	2.21
2.20 Store - Recall.....	2.22
2.21 Sequence.....	2.23
2.22 Special Functions.....	2.24
2.23 Self-Test .....	2.27
2.24 Status.....	2.27
2.25 Instrument Preset.....	2.30
2.25 IEC-Bus Address .....	2.31

### 3 Remote Control of Instrument via IEC Bus

<b>3.1</b>	<b>Brief Instructions for Simple Applications</b> .....	<b>3.1</b>
<b>3.2</b>	<b>Setting the Device Address</b> .....	<b>3.1</b>
<b>3.3</b>	<b>Device Messages</b> .....	<b>3.2</b>
3.3.1	Device-specific Setting Commands.....	3.2
3.3.2	Device-specific Data Request Commands and Messages Sent by the SMY.....	3.6
3.3.3	Common, Device-independent Setting Commands .....	3.9
3.3.4	Common, Device-independent Data Request Commands .....	3.10
3.3.5	Examples .....	3.11
3.3.6	Syntax of Setting Commands and Data Request Commands .....	3.12
3.3.7	Data Request and Syntax of the Messages Sent by the SMY to the Controller.....	3.15
3.3.8	Alternative Commands and Notations .....	3.17
3.3.9	Multiple Settings .....	3.17
<b>3.4</b>	<b>Interface Messages</b> .....	<b>3.19</b>
3.4.1	Universal Commands .....	3.19
3.4.2	Addressed Commands.....	3.19
<b>3.5</b>	<b>Service Request and Status Register</b> .....	<b>3.21</b>
<b>3.6</b>	<b>Command Processing Sequence and Synchronization</b> .....	<b>3.26</b>
<b>3.7</b>	<b>Error Handling</b> .....	<b>3.27</b>
<b>3.8</b>	<b>Resetting Device Functions</b> .....	<b>3.28</b>
<b>3.9</b>	<b>Local/Remote Switchover</b> .....	<b>3.28</b>
<b>3.10</b>	<b>Interface Function</b> .....	<b>3.29</b>
<b>3.11</b>	<b>IEC-Bus Connector and Bus Lines</b> .....	<b>3.30</b>

### 4 Maintenance and Troubleshooting

<b>4.1</b>	<b>Maintenance</b> .....	<b>4.1</b>
4.1.1	Cleaning the Exterior of the Instrument.....	4.1
4.1.2	Storage .....	4.1
<b>4.2</b>	<b>Function Check (Self-test)</b> .....	<b>4.1</b>
4.2.1	Self-test.....	4.1
4.2.2	Calibration.....	4.1

## 5 Testing the Rated Specifications

<b>5.1</b>	<b>Required Measuring Equipment and Accessories</b> .....	<b>5.1</b>
<b>5.2</b>	<b>Test Procedure</b> .....	<b>5.2</b>
5.2.1	Display and Keyboard.....	5.2
5.2.2	Frequency Setting.....	5.2
5.2.3	Reference Frequency .....	5.3
5.2.4	Settling Time.....	5.3
5.2.5	Output Level .....	5.4
5.2.6	Attenuation Set .....	5.4
5.2.7	Non-interrupting Level Setting .....	5.5
5.2.8	Output Reflection Coefficient.....	5.5
5.2.9	Harmonics .....	5.6
5.2.10	Spurious.....	5.7
5.2.11	SSB Phase Noise .....	5.7
5.2.12	Broadband Noise .....	5.9
5.2.13	Residual FM.....	5.9
5.2.14	Modulation Generator .....	5.10
5.2.15	Function Test of the External Modulation Level Monitoring.....	5.10
5.2.16	AM Modulation Depth .....	5.10
5.2.17	AM Distortion .....	5.11
5.2.18	AM Frequency Response .....	5.11
5.2.19	AM DC .....	5.11
5.2.20	Residual AM .....	5.11
5.2.21	Incidental $\phi$ M at AM.....	5.12
5.2.22	FM Deviation Setting .....	5.12
5.2.23	FM Distortion .....	5.12
5.2.24	FM Frequency Response .....	5.12
5.2.25	Incidental AM at FM.....	5.13
5.2.26	Stereo Modulation.....	5.13
5.2.27	PM Deviation Setting .....	5.13
5.2.28	PM Distortion .....	5.13
5.2.29	PM Frequency Response .....	5.14
5.2.30	Overvoltage Protection with OPTION SMY-B40.....	5.14
5.2.31	Overvoltage Protection without OPTION SMY-B40.....	5.14
5.2.32	Pulse Modulation with OPTION SMY-B40.....	5.15
5.2.33	Pulse Modulation without OPTION SMY-B40.....	5.15
<b>5.3</b>	<b>Performance Test Report</b> .....	<b>5.16</b>

## 6 Index

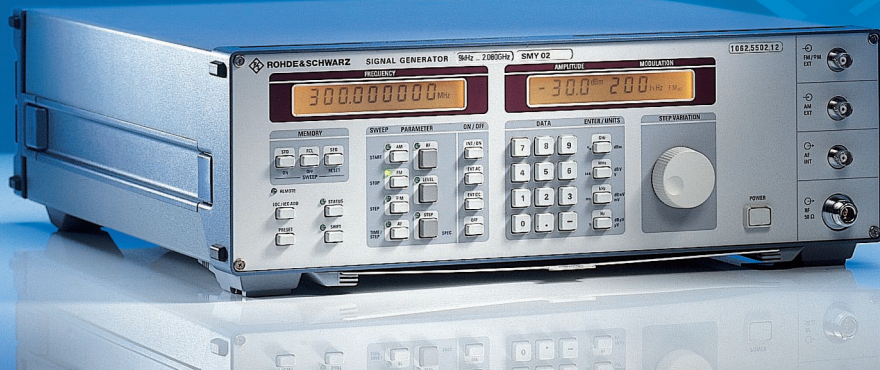

**NEW**

**up to 25 dBm**

**RF sweep**

**9 kHz to 1040/2080 MHz**

## Signal Generators SMY

Versatility and low cost can go hand in hand

- Frequency resolution 1 Hz
- Level range  $-140$  to  $+19$  dBm, overrange up to 25 dBm (option)
- Level accuracy better than 1 dB
- SSB phase noise  $< -114$  dBc at 1 GHz,  $\Delta f = 20$  kHz
- AM, FM,  $\phi$ M and pulse modulation
- Modulation generator 1 Hz to 500 kHz
- Sweep capabilities
- Nonvolatile memory for 100 complete front-panel setups
- RF overload protection 30 W (SMY01) or 50 W (SMY02)
- Low RF leakage ( $< 0.1 \mu\text{V}$ )
- Calibration at 3-year interval



**ROHDE & SCHWARZ**

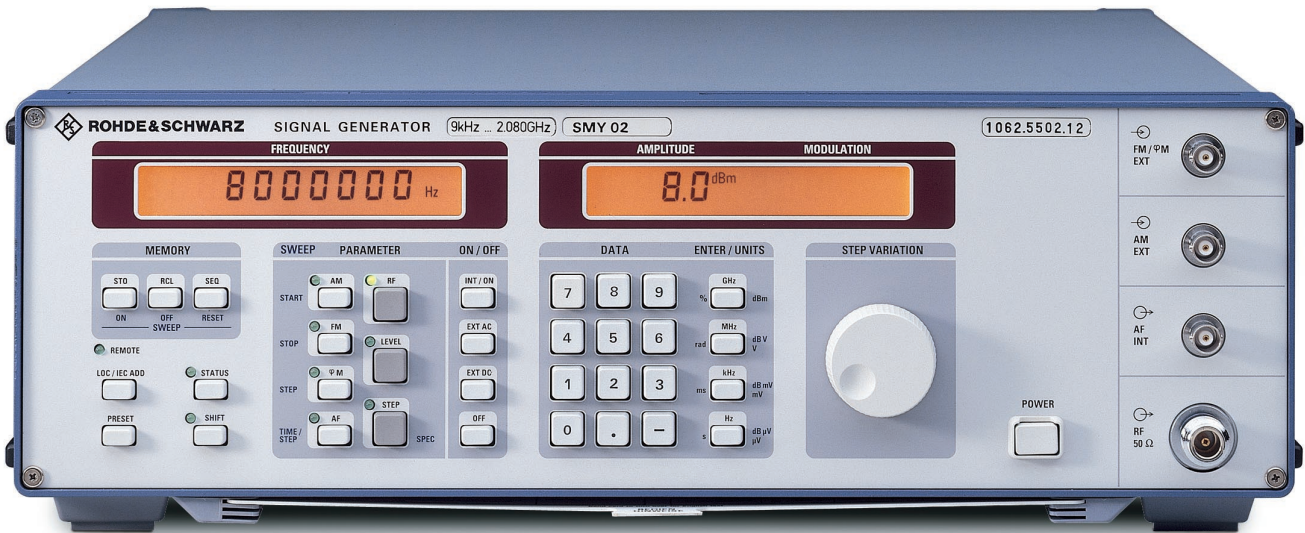

## SMY – the ideal generator for receiver measurements ...

Signal generators of the SMY family from Rohde & Schwarz are cost-effective instruments for testing AM, FM and  $\phi$ M receivers as well as for component measurements. Two models are available:

- SMY01 with a frequency range from 9 kHz to 1040 MHz
- SMY02 from 9 kHz to 2080 MHz.

Designed exclusively for the main applications of signal generators by cutting out the unnecessary, SMY features an outstanding price/performance ratio. Thanks to its comprehensive basic features and excellent signal characteristics, it is an economical solution for universal use in lab, production and servicing environments.

- Level range  $-140$  dBm to  $+13$  dBm ( $19$  dBm overrange <sup>\*)</sup>, sufficient even for receivers of highest sensitivity
- High level accuracy and low RF leakage allowing accurate and undegraded sensitivity measurements
- FM-DC with high accuracy of carrier frequency for testing pagers and receivers fitted with digital squelches
- Low SSB phase noise and high spurious rejection for all in-channel and blocking measurements
- Low residual FM affording ample of margin for S/N measurements
- Modulation generator 1 Hz to 500 kHz for modulation frequency response measurements
- Stereo channel separation of 50 dB and low harmonic distortion for testing FM stereo receivers

... and for general-purpose applications

Thanks to the excellent spectral purity and the high accuracy of the carrier frequency with FM-DC, measurements on steep-edged crystal filters are possible without any problem.

<sup>\*)</sup> With option SMY-B40  $-134$  dBm to  $+19$  dBm (25 dBm overrange)

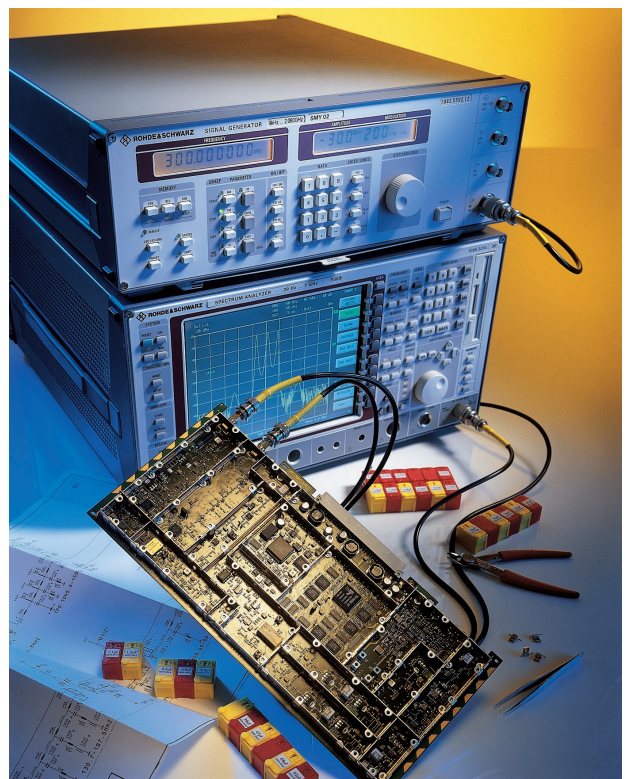



With option SMY-B40:  
The overrange feature for the output level allows measurements on high-level mixers. To the right: output level obtained with settings of 19 dBm, 21 dBm, 23 dBm and 25 dBm

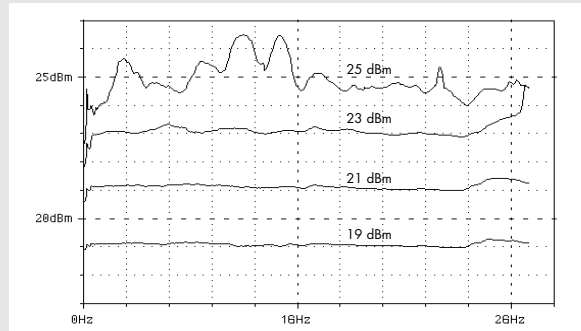

Accuracy of carrier frequency with FM-DC, long-term stability.  
Settings: carrier frequency = 1 GHz, FM deviation = 50 kHz, external FM-DC

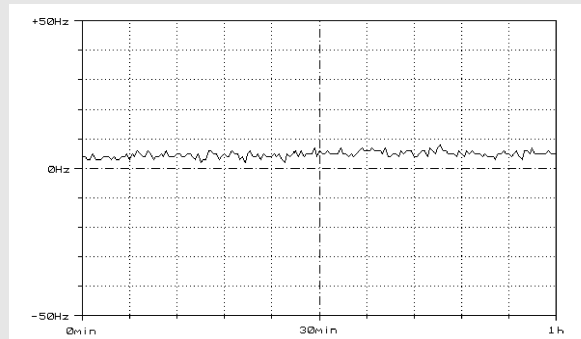

- Non-interrupting level setting over a range of 20 dB for reproducible measurement of squelch hysteresis
- Frequency resolution 1 Hz, suitable also for narrowband test items
- FM-DC, deviation up to 20 MHz for VCO simulation
- FM bandwidth 2 MHz for fast FSK and telemetry applications
- High output level up to 19 dBm (25 dBm with option SMY-B40) for component and overdrive testing
- AF synthesizer 1 Hz to 500 kHz, separate use as AF signal source for external applications possible, eg recording of AF frequency response
- Remote-control interface IEC 625/IEEE 488 for use in automatic test systems
- RF sweep
- Sequence function and SEQ input for semi-automatic use

FM frequency response of SMY.  
Frequency modulation is possible even at full deviation up to high modulation frequencies

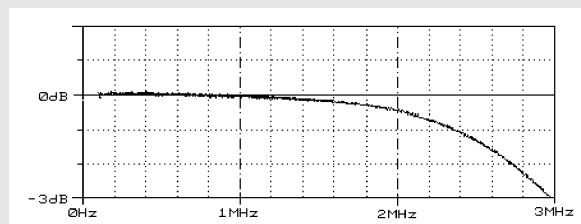

Level/frequency response at 0 dBm output level. The software-supported level correction reduces the frequency response to typically 0.1 dB

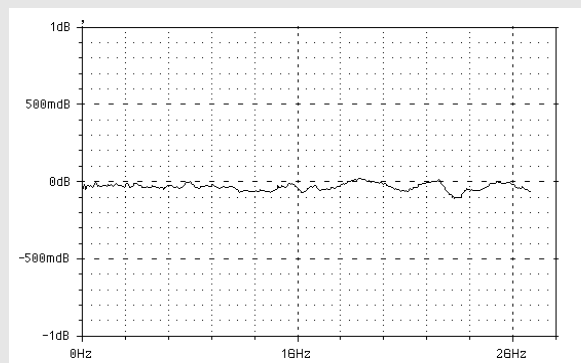

Phase-continuous frequency change of modulation generator.  
To the right: frequency change from 10 Hz to 40 Hz

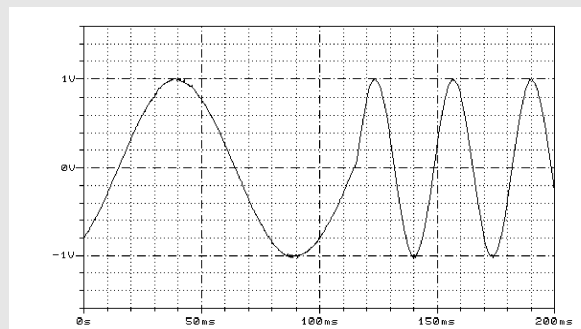



## Cost-saving synthesis concept

Single-loop synthesis is a concept that makes for simple and cost-effective circuit design and does not entail giving up high frequency resolution and short setting time. The fractional-N technique uses a fractional frequency division ratio, ie a frequency resolution of 1 Hz is obtained in spite of the high reference frequency. High reliability and light weight thanks to VLSI components are further advantages of this technique.

## Operation

The panel controls are ergonomically arranged so that there is no time wasted for familiarization. Operation is from the left to the right: parameters, data, units; each control is at its right place.

The patented, magnetically locking spinwheel is just as practical. Although easy to turn, each setting step is felt exactly by the user. Thus for instance it is not really necessary to observe the SMY display in the case of stepwise tuning. This means that the annoying procedure of looking back and forth between a

measuring instrument and the signal generator can be dispensed with. Naturally fast tuning and programming of the step width are also possible.

Frequently used settings can be stored and recalled any time. The memory saves up to 100 complete front-panel setups.

## Low cost of ownership thanks to high reliability and easy maintenance

Like with all Rohde & Schwarz signal generators, the well-proven self-test facility is integrated in SMY monitoring continuously the signal generator status. If there are any malfunctions, these are immediately detected and reported in the form of error messages. The user thus has an effective protection against invalid measurements, should the generator ever fail.

Thanks to its advanced circuit design, SMY requires particularly little maintenance. Aging and drift are compensated for by control loops. Due to the few reference components, which are desi-

gned for maximum stability, calibration is required at intervals of 3 years only.

If the accuracy is required to be higher than the specified data, user-specific calibration values for frequency and level may be entered and stored at any time without opening the instrument.

## Further development of proven technology

Signal Generators SMY from Rohde & Schwarz stands for the economy class of generators. Well-proven features have been improved and unnecessary details omitted. It is the sum of its characteristics which makes SMY so attractive. Tangible for the user are the variety of facilities and versatility at an excellent price/performance ratio. SMY is the economical solution for universal use in lab, production and servicing environments.

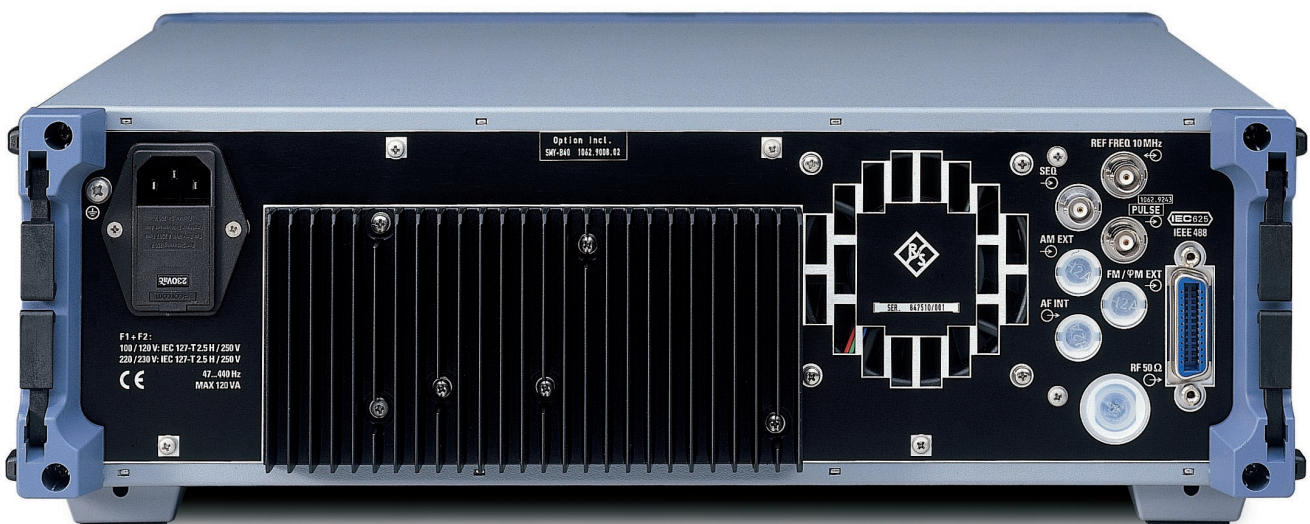

Rear-panel of SMY

## Specifications

<b>Frequency</b>		
Range	9 kHz to 1.04 GHz (SMY01) 9 kHz to 2.08 GHz (SMY02)	
Underranging without guarantee of specs	down to 5 kHz	
Resolution	1 Hz	
Setting time $t_{\text{set}}$ to within <math>1 \times 10^{-7}</math> for $f > 65$ MHz or <math>< 70</math> Hz for $f < 65$ MHz)	<math>< 60</math> ms	
<b>Reference frequency</b>	<b>standard</b>	<b>option SMY-B1</b>
Aging (after 30 days of operation)	$1 \times 10^{-6}$ /year	$< 1 \times 10^{-9}$ /day
Temperature effect (0 to 55 °C)	$2 \times 10^{-6}$	$< 5 \times 10^{-8}$
Warmup time	–	10 min
Output for internal reference		
Frequency	10 MHz	
Level (EMF, sinewave)	1 V (rms)	
Source impedance	50 $\Omega$	
Input for external reference		
Frequency	5 or 10 MHz $\pm 5 \times 10^{-6}$	
Input level	0.2 to 2 V (rms)	
Input impedance	200 $\Omega$	
<b>Spectral purity</b>	<b>standard</b>	<b>option SMY-B40</b>
Spurious		
Harmonics	<math>< -30</math> dBc for levels <math>< 10</math> dBm	<math>< -25</math> dBc for levels <math>< 16</math> dBm
Subharmonics		
$f \leq 1.04$ GHz	none	
$f > 1.04$ GHz	<math>< -40</math> dBc	
Nonharmonics at >5 kHz from carrier		
$f \leq 1.04$ GHz	<math>< -70</math> dBc	
$f > 1.04$ GHz	<math>< -64</math> dBc	
Broadband noise with CW <sup>1)</sup> , carrier offset >1 MHz, 1 Hz bandwidth		
$f = 1$ to 65 MHz	<math>< -135</math> dBc	
$f > 65$ MHz	<math>< -140</math> dBc	
SSB phase noise at 20 kHz from carrier, 1 Hz bandwidth, CW		
$f < 65$ MHz	<math>< -114</math> dBc	
100 MHz	<math>< -132</math> dBc	
500 MHz	<math>< -120</math> dBc	
1 GHz	<math>< -114</math> dBc	
2 GHz	<math>< -108</math> dBc	
Residual FM, rms, <math>< 1\%</math> of maximum deviation, $f = 1$ GHz		
0.3 to 3 kHz (CCITT)	<math>< 10</math> Hz, typ. 3 Hz	
0.03 to 20 kHz	<math>< 20</math> Hz, typ. 7 Hz	
Residual AM, rms (0.03 to 20 kHz) <sup>1)</sup>	<math>< 0.02\%</math>	
<b>Level</b>	<b>standard</b>	<b>option SMY-B40</b>
Range	–140 to +13 dBm	
Overranging without guarantee of specs	up to 19 dBm	up to 25 dBm, down to –140 dBm
Resolution	0.1 dB	
Total error for levels $> -127$ dBm <sup>1)</sup>		
$f < 1.04$ GHz	<math>< \pm 1</math> dB	
$f > 1.04$ GHz	<math>< \pm 1.5</math> dB	
Level flatness at 0 dBm <sup>1)</sup>	<math>< 1</math> dB, typ. <math>< 0.3</math> dB	
Output impedance VSWR <sup>1)</sup>	50 $\Omega$ <math>< 1.5</math> for $f \leq 1.04$ GHz <math>< 1.8</math> for $f > 1.04$ GHz	
Setting time (IEC/IEEE bus)	<math>< 25</math> ms (<math>< 10</math> ms with electronic level setting)	
Non-interrupting level setting (ATTENUATOR MODE FIXED) Setting range	0 to –20 dB	
<b>Overload protection</b>	protects the instrument against externally applied (50- $\Omega$ source) RF power and DC voltage	
Max. RF power		
SMY01	30 W	
SMY02	50 W	
Max. DC voltage	35 V	
Max. pulse loading capacity (pulse width <math>< 10</math> $\mu$ s)	1 mWs or 150 V ( $V_p$ )	

## Simultaneous modulation

any combination of AM, FM ( $\phi$ M) and pulse modulation

## Amplitude modulation

Modes	internal, external AC/DC	
Modulation depth	0 to 100% <sup>2)</sup>	
Resolution	0.1 %	
Setting error at 1 kHz ( $m < 80\%$ ) <sup>1)</sup>	<b>standard</b> <math>< 4\%</math> of reading $\pm 1\%$	<b>option SMY-B40</b> <math>< 4\%</math> of reading $\pm 3\%$
AM distortion at 1 kHz <sup>1)</sup>		
$f < 10$ MHz		
$m = 30\%$	<math>< 1\%</math>	<math>< 3\%</math>
$m = 80\%$	<math>< 2\%</math>	<math>< 5\%</math>
$f > 10$ MHz		
$m = 30\%$	<math>< 1\%</math>	<math>< 1\%</math>
$m = 80\%$	<math>< 2\%</math>	<math>< 2\%</math>
Modulation frequency response flatness ( $m = 60\%$ ) <sup>1) 3)</sup>		
30 Hz (DC) to 10 kHz	<math>< 0.4</math> dB	
10 Hz (DC) to 50 kHz	<math>< 3</math> dB	
Incidental $\phi$ M with AM (30%), AF = 1 kHz	<math>< 0.2</math> rad <math>< 0.4</math> rad at $f > 1.04$ GHz (SMY02)	
Modulation input (AM EXT)		
Input impedance	100 k $\Omega$ ; 600 $\Omega$ jumper-selected	
Input voltage for selected modulation depth	1 V (peak) (for inaccuracy >3%: high/low indication)	

## Frequency modulation

Modes	internal, external AC/DC	
Maximum deviation for carrier frequency		
<math>< 65</math> MHz	10 MHz	
65 to 130 MHz	1.25 MHz	
130 to 260 MHz	2.5 MHz	
260 to 520 MHz	5 MHz	
520 to 1040 MHz	10 MHz	
1040 to 2080 MHz	20 MHz	
Resolution	<math>< 1\%</math>, min. 10 Hz	
Setting error at AF = 1 kHz	<math>< 3\%</math> of reading + 20 Hz	
FM distortion at AF = 1 kHz and 3% of maximum deviation	<math>< 0.3\%</math>, typ. 0.1%	
Modulation frequency response flatness		
10 Hz (DC) to 2 MHz	<math>< 3</math> dB, typ. 1 dB	
Incidental AM at AF = 1 kHz, $f > 1$ MHz, 40 kHz deviation	<math>< 0.1\%</math>	
Stereo modulation at 40 kHz deviation, AF = 1 kHz		
Stereo separation <sup>4)</sup>	>50 dB	
S/N ratio		
unweighted	>76 dB	
weighted	>70 dB	
Harmonic distortion	typ. 0.1%	
Carrier frequency offset with FM-DC <sup>4)</sup>	<math>< 1</math> Hz + 0.1% of deviation	
Modulation input		
Input impedance	100 k $\Omega$ ; 600 $\Omega$ jumper-selected	
Input voltage for selected deviation	1 V (peak) (for inaccuracy >3%: high/low indication for AF = 10 Hz to 100 kHz)	

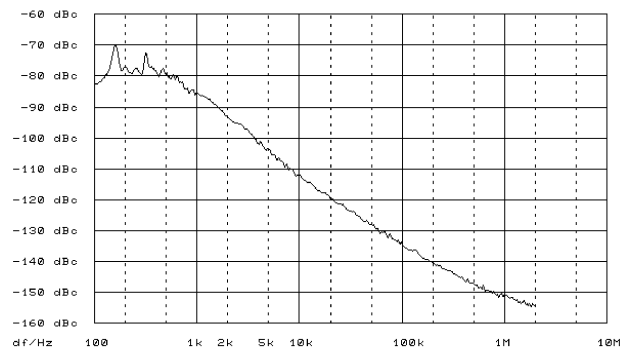

## Phase modulation

Modes	internal, external AC	
Maximum deviation for carrier frequency		
<65 MHz	200 rad	
65 to 130 MHz	25 rad	
130 to 260 MHz	50 rad	
260 to 520 MHz	100 rad	
520 to 1040 MHz	200 rad	
1040 to 2080 MHz	400 rad	
Resolution	<1%, min. 0.01 rad	
Setting error at AF = 1 kHz	<5% of reading + 0.02 rad	
FM distortion at AF = 1 kHz and half the maximum deviation	<0.5% (typ. 0.2%)	
Modulation frequency response flatness		
20 Hz to 20 kHz	<3 dB (typ. 1 dB)	
Modulation input	FM/φM EXT	
Input impedance	100 kΩ; 600 Ω jumper-selected	
Input voltage for selected deviation	1 V (peak) (for inaccuracy >3%: high/low indication)	

## Pulse modulation

Mode	<b>standard</b>	<b>option SMY-B40</b>
On/off ratio	external >80 dB	external >70 dB at 70 MHz, linearly decreasing to >65 dB at 520 MHz, >65 dB at 800 MHz, linearly decreasing to >35 dB at 2080 MHz
Rise/fall time (10/90%)	typ. 4 μs	<20 ns
Pulse delay	typ. 3.5 μs	<200 ns
Modulation input	BLANK	PULSE
Input impedance	10 kΩ	10 kΩ
Input level, standard	TTL/HC logic signal, polarity selectable	
Input level, option SMY-B40	TTL/HC logic signal, RF ON at high, RF ON at low jumper-selected	

## Internal modulation generator

Frequency range	1 Hz to 500 kHz
Resolution	0.1 Hz
Display	7 digits, floating point
Frequency error	<5 × 10 <sup>-5</sup>
Frequency response flatness	
up to 50 kHz	<0.2 dB
up to 100 kHz	<0.3 dB

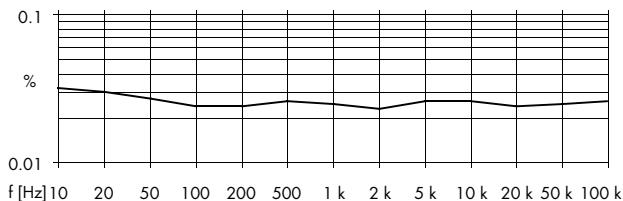

Typical harmonic distortion of AF synthesizer as a function of frequency

THD (20 Hz to 100 kHz)	<0.1 %
Output voltage	1 V (peak) ±1% (R <sub>out</sub> <10 Ω, R <sub>L</sub> >200 Ω)
Frequency setting time	<10 ms (after receiving last IEC/IEEE-bus character)

## RF sweep

Mode	digital sweep in discrete steps
Sweep range and step width	automatic, linear user-selected
Step duration	10 ms to 5 s
Resolution	1 ms

## Memory

non-volatile, for 100 instrument setups

## Remote control

System	IEC 625 (IEEE 488)
Connector	Amphenol, 24-contact
IEC/IEEE-bus address	0 to 30
Interface functions	SH1/AH1/T6/L4/SR1/RL1/PPO/ DC1/DT0/CO

## General data

### Temperature range

Guaranteed specs	0 to 55 °C; complying with IEC68-2-1 and IEC68-2-2
Storage temperature	-40 to +70 °C

### Climatic conditions

Humidity	95% relative humidity at +40 °C; complying with IEC68-2-3
----------	---

### Mechanical resistance

Sinewave vibration	5 to 150 Hz, max. 2 g at 55 Hz, max. 0.5 g in range 55 to 150 Hz, complying with IEC68-2-6, IEC1010-1 and MIL-T-28800D, class 5
--------------------	---

### Electromagnetic compatibility

RF leakage	complying with EN50081-1 and EN50082-1 (EMC Directives of EU) <0.1 μV (measured with a two-turn coil of 2.5 cm in diameter at a distance of 2.5 cm from any point of enclosure)
Radiated susceptibility	10 V/m

### Power supply

100 V/230 V (AC) -10 to +15%,  
120 V/220 V (AC) -12.5 to +10%,  
47 to 440 Hz, max. 120 VA

### Safety

complying with EN61010-1

### Dimensions (W x H x D)

SMY01	435 mm x 147 mm x 350 mm
SMY02	435 mm x 147 mm x 460 mm

### Weight

12 kg (SMY01), 13 kg (SMY02)

## Ordering information

<b>Signal Generator</b>	SMY01	1062.5502.11
	SMY02	1062.5502.12

### Accessories supplied

power cord, operating manual

### Options

Reference Oscillator OCXO	SMY-B1	1062.7505.02
Rear-Panel Connectors for RF and NF	SMY-B10	1062.8001.02
Pulse Modulator and High Output Power <sup>5)</sup>	SMY-B40	1062.9008.02

### Recommended extras

19" Rack Adapter	ZZA-93	0396.4892.00
Service Kit	SMY-Z2	1062.7805.02
Service Manual		1062.5583.24

<sup>1)</sup> Valid for levels ≥ -127 dBm (≥ -121 dBm with option SMY-B40), not with special function »non-interrupting level setting«.

<sup>2)</sup> The modulation depth selectable within the guaranteed AM specifications linearly decreases for levels from 7 to 13 dBm (13 to 19 dBm with option SMY-B40). A status message appears if the modulation depth is too high.

<sup>3)</sup> Does not apply to special function »ALC – bandwidth, narrow«.

<sup>4)</sup> Valid after calibration for one hour and for temperature variations <5 °C.

<sup>5)</sup> To be retrofitted by authorized service centers only.



**ROHDE & SCHWARZ**

ROHDE & SCHWARZ GmbH & Co. KG · Mühlhofstraße 15 · D-81671 München

P.O.B. 801469 · D-81614 München · Telephone +4989 4129-0 · Fax +4989 4129-3567 · Internet: <http://www.rsd.de>

# 1 Preparation for Use

## 1.1 Putting into Operation

Before putting the SMY into operation, see to it that

- the covers of the casing are put on and bolted,
- the ventilation ducts are free,
- there are no signal voltage levels exceeding the permissible limits present at the inputs,
- the outputs of the instrument are not overloaded or connected incorrectly.

If this is not observed, the instrument might be damaged.

## 1.2 Power Supply/Power Fuses

The SMY can be operated at a.c. systems of 100 to 120 V and 200 to 240 V at system frequencies of 47 to 440 Hz. The power supply socket is at the rear of the instrument.

Adaption of the power supply, exchange of the power fuse:

- Withdraw the power supply cable.
- Open the cover of the voltage selector at the rear of the instrument using a screwdriver.
- Remove the coding cylinder now accessible and set in in such a way that the voltage value desired can be read from outside.
- Close the cover pressing it firmly.
- Check whether the voltage value desired is visible from outside in the window of the cover.

## 1.3 Mounting into a 19" Rack

The SMY can be mounted into a 19" rack by means of rack adapter ZZA-93 (stock no. 396.4892.00). The mounting instructions are attached to the adapter.

**Caution:** *When mounting into the rack, ensure unhindered admission of air at the perforation of the side panels and air escape at the rear of the instrument.*

## 1.4 Option SMY-B1

The SMY can be equipped with option SMY-B1, reference oscillator, OCXO.

Reference  $\square$  is briefly displayed in the amplitude/modulation display after switch-on of the instrument if the option has been fitted.

Further details can be found in section "Reference Frequency Int/Ext." as well as the data sheet.

### Subsequent fitting of option SMY-B1:

The crystal oscillator has been tuned to nominal frequency with R&S and the appropriate tuning voltage noted on the option. Note this tuning voltage down on a note sheet as the value must be transmitted into the memory of the signal generator after fitting the option.

The fitted option is automatically recognized from the firmware.

- Opening the casing**
- Loosen four screws in the two rear panel feet and withdraw feet.
  - Withdraw the upper cover to the rear.
  - Turn the instrument.
  - Withdraw the lower cover to the rear.
- Fitting the option**
- The option is fitted behind the modules at the free space of the left side panel in such a way that the ribbon cable is at the top. It is fastened mechanically at the side panel by means of the 4 screws supplied.
  - Insert ribbon cable W22 into socket X22 of the power supply unit.
  - Withdraw coaxial cable W28 from socket X711 of the option and connect it to socket X128 of module A4 "synthesis".
- Closing the casing**
- Fix the upper and lower cover in the reverse order as in opening the instrument.
  - Insert and screw down the rear panel feet.
- Set the tuning voltage**
- Switch on special function "Calibration REF-OSC" by means of code 51.
  - Using the tuning voltage previously noted, calculate a value for setting the D/A converter (DAC) according to the following equation:  
$$\text{DAC} = 4096 \times \frac{\text{tuning voltage}}{10 \text{ V}}$$
  - Enter the DAC value.
  - Terminate special function "Calibration REF-OSC" by means of code 52.

The crystal oscillator can be recalibrated to compensate for aging. Calibration is described in the service manual.

## 1.5 Option SMY-B40

The SMY can be equipped with option SMY-B40, pulse modulator and high output power.

The note  $\square$  4  $\square$  is briefly displayed in the amplitude/modulation display after switch-on of the instrument if the option has been fitted.

Further details can be found in the sections "Level" and "Pulse Modulation" as well as in the data sheet.

Fitting or disassembling option SMY-B40 is only possible at the factory or at authorized service centers.

## 2 Manual Operation

Signal generator SMY can be operated easily and comfortably. It can be set via the keyboard, the rotary knob variation and via the IEC-bus remote control interface (remote control of the SMY is described in detail in section 3).

On the following pages, you will find the front and rear panel views of the instrument, each with short explanations.

If you are getting familiar with the SMY and like to have a fast overview, please read section 2.2, "Pattern Setting for First Users", and then section 2.3, "Basic Operation" first.

The complete functions of the manual operation are described as of Section 2.4.

Values mentioned in this section are not guaranteed, only the technical data in the specifications are binding.

## 2.1 Front and Rear Views

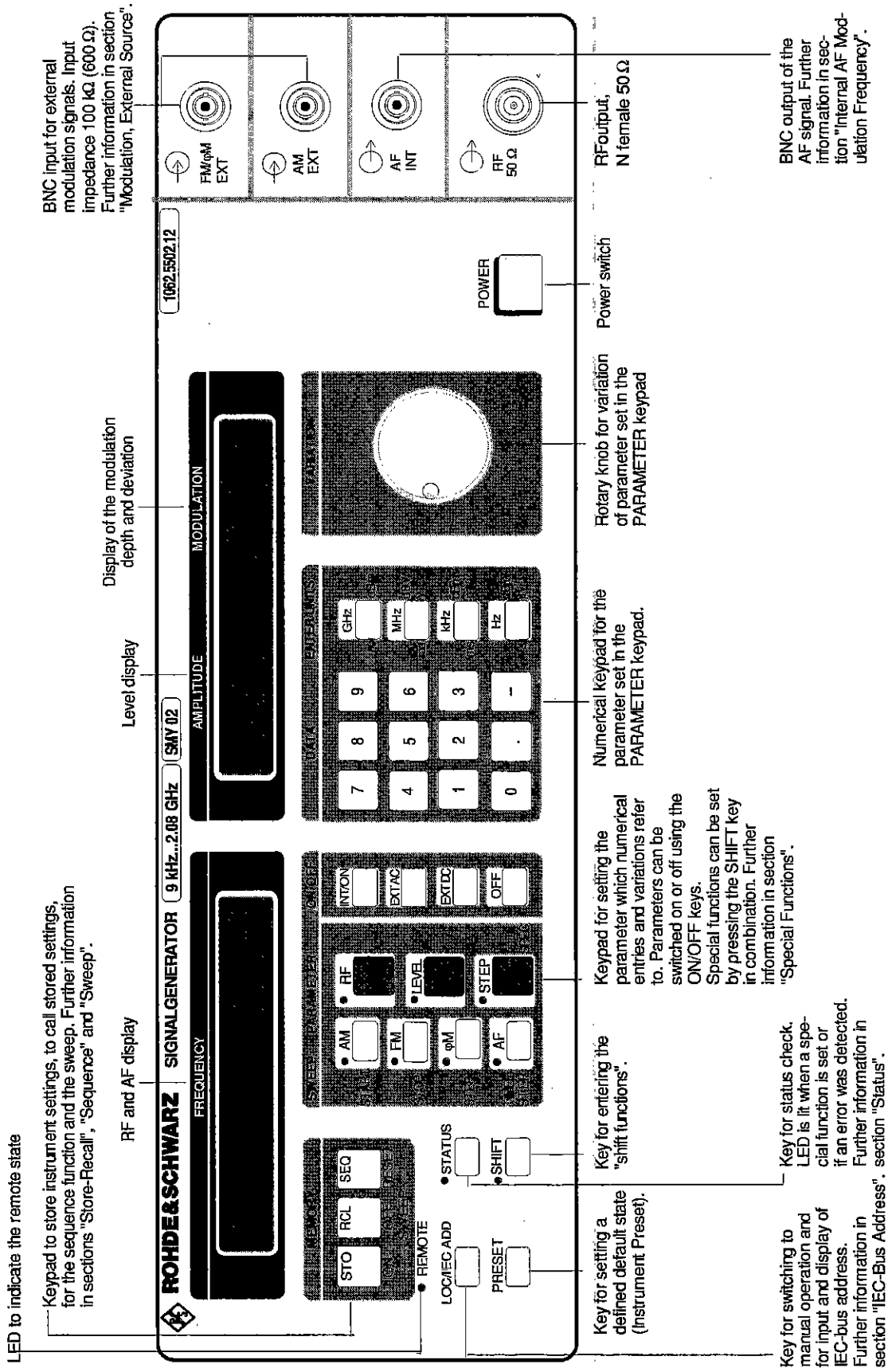



Output of the internal reference frequency when internal reference mode is set. Input of the external reference frequency when external reference mode is set. Further information in section "Internal/External Reference Frequency."

BNC input for sequentially recalling stored settings. A short to ground has the same effect as pressing the SEQ key. Further information in section "Sequence".

Fuse values for the different AC supply voltages.

Line voltage connection, fuse holder and line voltage selector

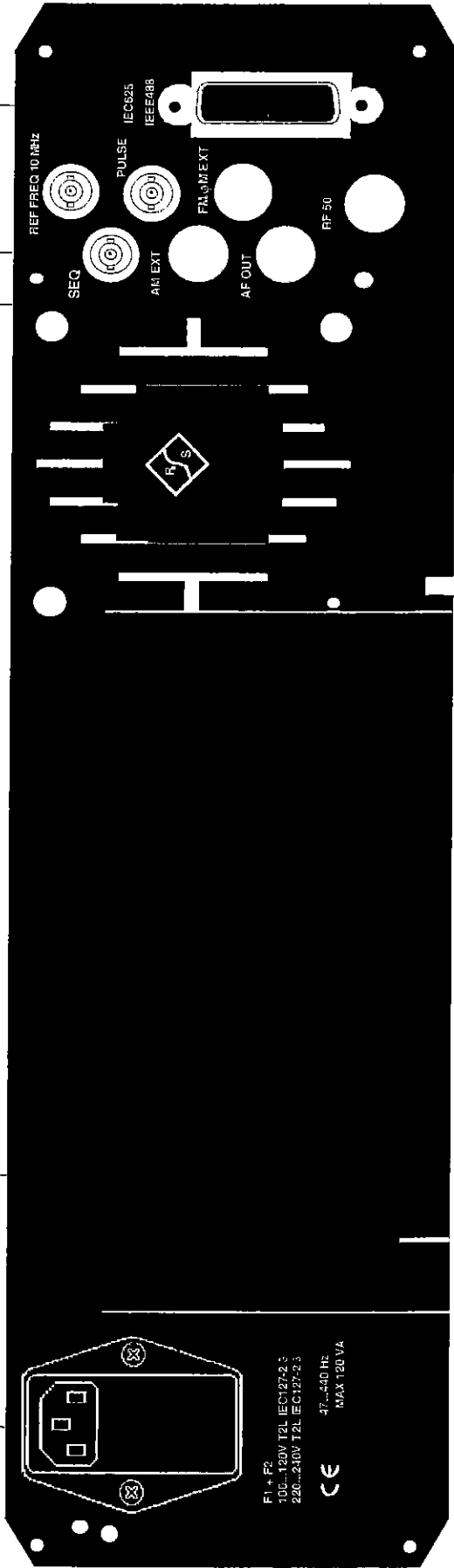

IEC-bus connector for remote control

Cut-outs provided for fitting the corresponding front panel connectors to the rear panel of the unit.

Cut-out provided for fitting the front panel RF output to the rear panel of the unit.

## 2.2 Pattern Setting for First Users

The fastest way for first users to get familiar with the operation of the instrument is to execute the pattern setting of this section.

A setting is made from the left to the right in the order Parameter — Data — Unit.

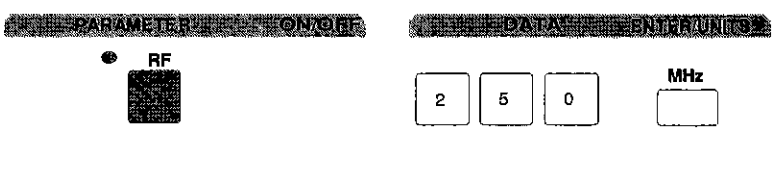
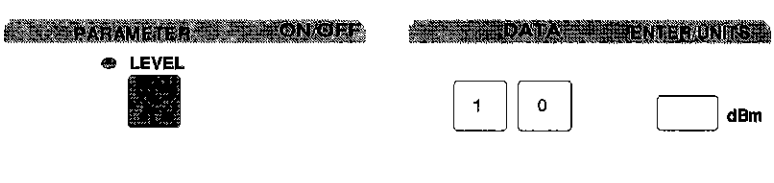
Operating steps	Explanations
	Reset instrument to the defined status.
	Set RF to 250 MHz.
	Set level to 10 dBm.

## 2.3 Basic Operation

### Selection of the Parameters

The PARAMETER ON/OFF keypad is used to set the parameter to which numerical entries and variations refer. The set parameter is indicated by the LED flashing. Only one parameter can be set at a time. The only exception is the STEP parameter which is set at the same time as another parameter (to enter the step size for the STEP function). The SHIFT parameters (blue inscription) SWEEP ON, OFF, RESET, START, STOP, STEP, TIME/STEP and SPEC are set by pressing the SHIFT key before the corresponding parameter key.

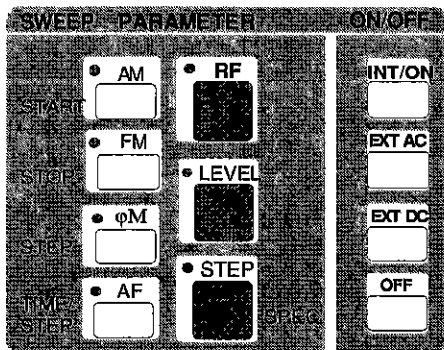

Fig. 2-1 PARAMETER ON/OFF keypad

### Switching the parameters on and off

Parameters which can be switched on and off are AM, FM, φM, AF, LEVEL.

The parameters are switched on by pressing the parameter key and then one of the three ON keys (INT/ON, EXT AC and EXT DC) in the parameter keypad. The parameters are then switched to the stored value of the last setting.

The parameters can also be switched to numerical entry using one of the ENTER/UNITS keys. If the data input is then omitted, the parameter is set again to the stored value of the last setting.

The parameters are switched off by pressing the parameter key and then the OFF key in the ON/OFF key column of the parameter keypad.

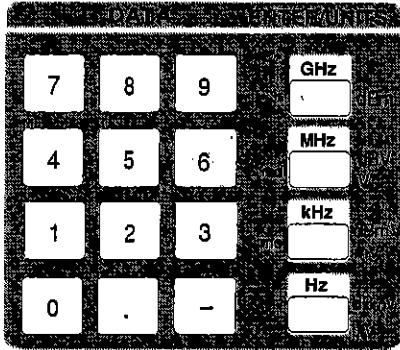

Fig. 2-2 DATA and ENTER/UNITS keypad

### Numerical entry

A value is entered in the order Parameter — Data — Unit:

Example	Input
Setting the RF to 1 MHz	

The parameter need not be set again for further entries once it has been set (parameter LED on). This does not apply to parameters SPEC, IEC ADD and STEP which only remain set for **one** entry.

The value is set by pressing an ENTER/UNITS key.

Numerical entries must always be terminated by pressing one of the ENTER/UNITS keys. Any of the four ENTER/UNITS keys can be used for parameters without a unit.

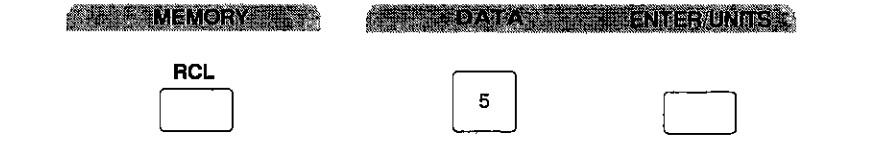
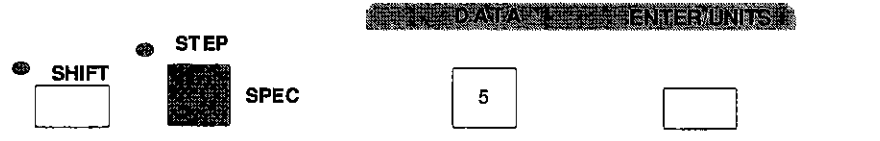
Example	Input
Calling memory location setting 5	
Switch-on of special function AM two-tone	

### Correction of entry

An entered value can be cleared before being set (i. e. before pressing one of the ENTER/UNITS keys) by pressing the key of the set parameter (LED on) or one of the other parameters.

Entries made via the numerical keypad can be corrected with the key "-" as long as one of the ENTER keys was not pressed. One digit is cleared each time the key "-" is pressed.

### Changing the unit

In order to change the unit displayed, set the parameter (RF or LEVEL) and press the required unit in the ENTER/UNITS column.

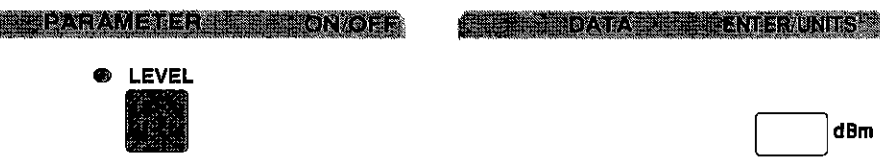
Example	Input
The level is displayed in mV and shall be displayed in dbm.	

The parameter key need not be pressed again if the parameter has already been set (LED on).

## **Displays**

The RF is output with up to 10 digits in the **FREQUENCY display**:

The following is also output in this display:

- step size for STEP variation of RF,
- start and stop frequency as well as frequency step and step time for the RF sweep,
- AF up to 7 digits,
- status codes of the set special functions,
- external reference mode and
- the IEC-bus address.

The following is output in the **AMPLITUDE display**:

- level of the RF signal,
- step size for the STEP variation of the level,
- measured values of internal test points (diagnostic test),
- reference OVERLOAD if the RF output is externally overloaded and
- indication of the fitted options.

The following is output in the **MODULATION display**:

- type of modulation switched on,
- parameters modulation depth and deviation,
- step sizes for the STEP variation of the modulation parameters and AF
- warning LOW or HIGH if the external modulation voltage is not equal to 1 V ( $V_p$ ),
- number of memory location for STO, RCL and SEQ,
- fine variation range with special function "non-interrupting level setting" on,
- numbers of internal test points (diagnostic test) and
- status codes of function/input errors and overrange/underrange settings.

### **Display of functions which are not switched on**

The parameters of functions which are not switched on such as AM modulation depth or FM deviation are displayed as long as the respective parameter key is pressed.

### **Display of entered numerical value**

While entering a numerical value (DATA keys), the digits of the newly entered value are progressively output in the display of the related parameter.

## Variation

Parameters AM modulation depth, FM deviation,  $\phi$ M deviation, AF, RF and LEVEL can be varied.

The parameter currently set in the parameter keypad can always be varied using the rotary knob.

For further information, please see section "Variation, Rotary Knob".

## Store - recall

The generator can store settings which can later be recalled. This function is accessed using the keys in the MEMORY keypad. Further information in sections "Store- Recall" and "Sequence".

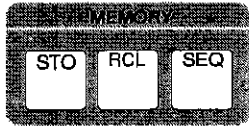

Fig. 2-3 MEMORY keypad

## Special functions

Special functions extend the given settings indicated on the front panel. Further information in section "Special Functions".

## Status

Input errors are indicated in the modulation display by a brief appearance of the status code identifying the error and flashing of the STATUS LED.

Function errors are indicated by continuous flashing of the STATUS LED. The status code describing the error appears in the modulation display when the STATUS key is pressed.

Overrange/underrange settings are indicated by continuous lighting of the STATUS LED. The status code describing the setting appears in the modulation display when the STATUS key is pressed.

Continuous lighting of the STATUS LED also indicates that a special function is switched on. The status code describing the special function is output in the frequency display by pressing the STATUS key. Further information in section "Status".

## IEC-bus address

The IEC-bus address can be output in the frequency display and set via the keyboard. Further information in section "IEC-bus Address".

## Instrument preset

The generator is set to a defined basic status by means of key PRESET. For further information, please see section "Instrument Preset".

## 2.4 Power-on Status

The generator has the same status when switched on as before switching off.

### Exceptions:

- Local mode is always set.
- An RQS can be output on the IEC bus each time the instrument is switched on.
- For setting the registers of the service request function, see sections "Service Request and Status Registers" and "Resetting Device Function".

A function test is carried out following switch-on. The ROM, EPROM and RAM contents are checked. The LED of the STATUS key flashes if an error is detected. The associated status display is output in the modulation display by pressing the STATUS key.

The preset status is set if the status prior to switch-off cannot be set again because of a memory error.

**Display:** The IEC-bus address set is displayed in the frequency display and the fitted options are indicated in the amplitude/modulation display following power-on for a brief period.

## 2.5 Internal/External Reference Frequency

The internal standard reference source of the SMY is a 10-MHz crystal oscillator. Higher demands on frequency accuracy are satisfied by the option Reference Oscillator SMY-B1, OCXO. Subsequent fitting of this option is described in section "Option SMY-B1".

In internal reference mode, the internal reference signal with a frequency of 10 MHz is present at the female connector REF FREQ 10MHz.

In external reference mode, an external signal with a frequency of 5 or 10 MHz must be fed into the female connector REF FREQ 10MHz. Synchronization to 5 or 10 MHz is automatic.



Frequency at the input/output

REF FREQ 10MHz: 10 MHz

Internal reference mode: Signal output  
( $V_{rms} = 1V$ , EMF),  
female connector REF FREQ 10MHz at the rear panel.

External reference mode: Signal input ( $0.2 V \leq V_{rms} \leq 2 V$ ,  
sinewave, squarewave or TTL),  
female connector REF FREQ 10MHz at the rear panel.

The internal or external reference is selected using the keyboard or via the IEC bus.

Example	Input	IEC-Bus Code
Setting for external reference	 <p>The diagram shows a connector with two RF ports. The top RF port is selected with a dot, and the switch is labeled 'EXT'.</p>	REFERENCE_OSCILLATOR:EXTERNAL
Setting for internal reference	 <p>The diagram shows a connector with two RF ports. The bottom RF port is selected with a dot, and the switch is labeled 'INT/ON'.</p>	REFERENCE_OSCILLATOR:INTERNAL

**Display:** The note "REF EXT" appears in the frequency display if the external reference mode has been selected.

**Note:** The externally applied reference frequency of 10 MHz must not deviate by more than  $\pm 5 \cdot 10^{-6}$  from 10 MHz.

**Associated instructions:** Special function "Calibration REF-OSC"

## 2.6 Frequency (RF)

**Range:** 9 kHz to 1040 MHz (2080 MHz with SMY02, adjustable as from 5 kHz without guarantee of rated specifications)  
**Resolution:** 1 Hz  
**Units:** GHz, MHz, kHz, Hz  
**Setting:** RF — data — unit

Example	Input	IEC-Bus Code
Setting the RF to 500 MHz		RF 500MHZ

**Display:** The RF output frequency appears in the frequency display.

**Associated instructions:** Internal/external reference frequency

## 2.7 LEVEL

**Range:** -140 to 13 dBm (settable up to 19 dBm without guarantee of rated specifications)  
 -134 to 19 dBm with option SMY-B40 (settable as from -140 dBm up to 25 dBm with restricted data)  
**Resolution:** 0.1 dB  
**Units:** dBm, V, mV,  $\mu$ V, dBV, dBmV, dB $\mu$ V  
**Setting:** [SHIFT] — LEVEL — data — unit

Example	Input	IEC-Bus Code
Setting of level 60 dB $\mu$ V		LEVEL 60DBUV
Switching off the level		LEVEL:OFF
Switching on the level to the stored value		LEVEL:ON

**Associated instructions:** Non-interrupting level setting  
 Level EMF

**Note:** For output levels > 19 dBm and mismatch load termination of the SMY's RF-output the overvoltage protection of the attenuator can respond to the RF-voltage generated internally (indication OFF and blinking OVERLOAD message in the AMPLITUDE display). The protection switch can be reset by entering a level of < 19 dBm and pressing the INT/ON key.



## 2.8 Non-Interrupting Level Setting

Independent of the set value, the special function "Non-interrupting level setting" permits to attenuate the level electronically up to 20 dB without interruption, i. e. without using the interrupting mechanical attenuator. The value set when switching on the special function is used as reference level. Within the 20-dB range, the level can be set via the keyboard or the IEC bus.

Setting of a level outside the 20-dB range is made using the interrupting mechanical attenuator set. Starting at this new level, further level settings are made non-interruptive again in the range 0 to -20 dB.

If the special function "Non-interrupting level setting" is switched on again when already having been switched on, this has the same effect as if the special function were switched on for the first time, i. e. the full setting range 0 to -20 dB is then available with respect to the set level.

Switching on special function with code 1 } see special functions  
Switching off special function with code 2 }

**Note:** *Specifications concerning level error, modulation depth error and distortion factor with AM do not apply with the special function "Non-interrupting level setting" switched on.*

**Associated instructions:** LEVEL  
Level EMF  
Special functions

## 2.9 Level Control Without Function

With the special function "Level control without function" (ALC off), internal level control is switched over to a sample-and-hold mode. This special function is used for multi-transmitter measurements to achieve a higher signal-to-intermodulation ratio. The self-intermodulation products of two generators connected using a signal divider (2 x 50  $\Omega$ ) remain below the following values:

Without option SMY-B40:  
for output levels of 13 dBm                      below -40 dBc  
for output levels of less than 0 dBm           below -70 dBc

With option SMY-B40:  
for 19 dBm    below -50 dBc  
for 16 dBm    below -60 dBc  
for 10 dBm     below -70 dBc.

In this special function, the SMY can be operated as usual.

Switching on special function with code 21

Switching off special function with code 22

**Note:** *The specifications in the data sheet concerning level error, AM and VSWR do not apply in the special function "ALC off".*

**Associated instructions:** LEVEL  
Level EMF  
Special functions

## 2.10 Level EMF

With the special function "Level EMF", the EMF value of the RF voltage is displayed and no longer the value of the RF voltage into 50 Ω. The EMF display appears if one of the units dBμV, dBmV, dBV, V, mV or μV is selected.

Switching on special function with code 3 } see special functions  
 Switching off special function with code 4 }

### Associated

**instructions:** LEVEL  
 Non-interrupting level setting  
 Special functions

## 2.11 Internal AF Modulation Frequency

**Frequency range:** 1 Hz to 500 kHz

**Resolution:** 0.1 Hz

**Resolution of Display:** 7-digit

As a modulation source, the SMY contains an AF synthesizer which is also brought out to be used externally at socket AF INT. The AF signal at the socket is automatically switched on if an internal modulation is activated. It can also be switched on if no internal modulation is activated. The output amplitude is 1V (V<sub>p</sub>).

**Setting the frequency:** AF — Data — Unit

Example	Input	IEC-Bus Code
Setting the AF (int. modulation frequency) to 400 Hz	<p>PARAMETER ON/OFF      DATA      ENTER/MEMO</p> <p>● AF      4   0   0      Hz</p>	AF 400HZ
Switching on the AF signal to the stored value	<p>● AF      INT/ON</p>	AF:ON
Switching off the AF signal	<p>● AF      OFF</p> <p>(no effect if internal modulation switched on)</p>	AF:OFF

**Display:** The frequency display indicates both the RF and the AF. The value of the parameter pressed last in the parameter keypad is displayed. An AF-value is characterized by the characters "AF" in front of the numeric value.

### Associated

**instructions:** Modulation (AM, FM, φM)  
 Two-tone modulation

## 2.12 Modulation, AM

**Modulation depth:** 0 to 100 %  
**Resolution:** 0.1 %  
**Ext. modulation frequency range:** DC to 50 kHz  
**Internal modulation frequencies:** 1 Hz to 50 kHz

The internal modulation source and one external modulation source can be switched on simultaneously (see section "Two-tone modulation").

For increasing levels between 7 dBm and 13 dBm (or between 13 dBm and 19 dBm with option SMY-B40), AM specifications are guaranteed only if the modulation depth decreases linearly.

When AM is switched on, the ALC bandwidth is automatically set to "broad" if the special functions 13 and 15 are not active.

The AM specifications are not valid in the special function "ALC bandwidth narrow" (Spec 13).

Setting too large a modulation depth causes the status LED to light up. In this case, the status indication in the modulation display is 70 (see section "Status").

**Setting:** AM — Data — %  
**Selection of modulation source:** AM — INT/ON or AM — EXT AC (EXT DC)  
**Selection of internal modulation frequency:** See section "Internal AF Modulation Frequency".  
**Switching off the AM:** AM — OFF  
**Switching on the AM to the stored value (new value not entered):** AM — INT/ON or AM — EXT AC (EXT DC)

Example	Input	IEC-Bus Code
Setting and switching on the AM with m=80 %		AM 80PCT
Selection of the external modulation source		AM:EXTERNAL:AC
Switching off the AM		AM:OFF

**Display:**  % AM<sup>EXT</sup>

If amplitude modulation is switched on, this is indicated by

AM<sup>EXT</sup>, AM<sup>EXT DC</sup>, AM<sub>INT</sub><sup>EXT</sup>, AM<sub>INT</sub><sup>EXT</sup> and AM<sub>INT</sub><sup>EXT DC</sup>

depending on the modulation source selected.

The modulation depth is output in 3 digits in the modulation display. The display is common to the modulation depth with AM and the deviation with FM/φM. The value of the parameter AM, FM or φM pressed last in the parameter keypad is displayed.

#### **Comment on AM DC:**

This mode enables external level control or regulation via level detectors with a negative or positive detector voltage.

Modulation frequency..... DC to 50 kHz  
Modulation depth..... 0 to 100 %  
Input voltage..... -1.0 V to +1.0 V

The level variation range is determined by the modulation depth input. A range from -1 V to +1 V corresponds to a change in level from level<sub>0V</sub> · (1-m) to level<sub>0V</sub> · (1+m). With special function AM invers active this level variation is obtained for inverted polarity of the input voltage. This allows to decrease the level by means of a positive input voltage.

Level<sub>0V</sub> is the RF level in V entered numerically.

The maximum control range, e.g. for maximum carrier blanking, is at m = 100 %.

#### **Associated**

**instructions:** LEVEL  
Internal AF modulation frequency  
Modulation, external source  
Two-tone modulation  
Pulse modulation  
Special function ALC bandwidth  
Special function AM invers



Example	Input	IEC-Bus code																
Setting and switching on the FM with 40 kHz deviation  Selection of modulation source EXT AC  Switching off the FM	<table border="1"> <thead> <tr> <th data-bbox="464 340 707 368">PARAMETER</th> <th data-bbox="707 340 839 368">ON/OFF</th> <th data-bbox="839 340 1186 368">DATA</th> <th data-bbox="1186 340 1186 368">UNITS</th> </tr> </thead> <tbody> <tr> <td data-bbox="464 368 707 454"> <input checked="" type="radio"/> FM  <input type="checkbox"/> </td> <td data-bbox="707 368 839 454"></td> <td data-bbox="839 368 1186 454"> <input type="text" value="4"/> <input type="text" value="0"/> </td> <td data-bbox="1186 368 1186 454">kHz</td> </tr> <tr> <td data-bbox="464 454 707 541"> <input checked="" type="radio"/> FM  <input type="checkbox"/> </td> <td data-bbox="707 454 839 541"> <input type="checkbox"/> EXT AC  <input type="checkbox"/> </td> <td data-bbox="839 454 1186 541"></td> <td data-bbox="1186 454 1186 541"></td> </tr> <tr> <td data-bbox="464 541 707 627"> <input checked="" type="radio"/> FM  <input type="checkbox"/> </td> <td data-bbox="707 541 839 627"> <input type="checkbox"/> OFF  <input type="checkbox"/> </td> <td data-bbox="839 541 1186 627"></td> <td data-bbox="1186 541 1186 627"></td> </tr> </tbody> </table>	PARAMETER	ON/OFF	DATA	UNITS	<input checked="" type="radio"/> FM <input type="checkbox"/>		<input type="text" value="4"/> <input type="text" value="0"/>	kHz	<input checked="" type="radio"/> FM <input type="checkbox"/>	<input type="checkbox"/> EXT AC <input type="checkbox"/>			<input checked="" type="radio"/> FM <input type="checkbox"/>	<input type="checkbox"/> OFF <input type="checkbox"/>			FM 40KHZ  FM:EXTERNAL:AC  FM:OFF
PARAMETER	ON/OFF	DATA	UNITS															
<input checked="" type="radio"/> FM <input type="checkbox"/>		<input type="text" value="4"/> <input type="text" value="0"/>	kHz															
<input checked="" type="radio"/> FM <input type="checkbox"/>	<input type="checkbox"/> EXT AC <input type="checkbox"/>																	
<input checked="" type="radio"/> FM <input type="checkbox"/>	<input type="checkbox"/> OFF <input type="checkbox"/>																	

**Display:**

4 0 kHz FM<sup>EXT</sup>

If frequency modulation is switched on, this is indicated by

FM<sup>EXT</sup>, FM<sup>EXT DC</sup>, FM<sup>INT</sup>, FM<sup>EXT INT</sup> or FM<sup>EXT DC INT</sup>

depending on the modulation source selected.

The deviation is output in 3 digits in the modulation display. The display is common to the deviation with FM and the modulation depth with AM. The value of parameter AM, FM or φM pressed last in the parameter keypad is displayed.

**Associated instructions:**

- Internal AF modulation frequency
- Modulation, external source
- Two-tone modulation
- Special functions

## 2.15 Modulation, M

**Deviation:**..... 0 to 400 rad (depending on the carrier frequency)

**Resolution:** ..... 0.001 to 1 rad (depending on the deviation range)

**External modulation frequency range:** ..... 20 Hz to 20 kHz

**Internal modulation frequency range:** ..... 20 Hz to 20 kHz

The internal and one external modulation source can also be switched on simultaneously (cf. section "Two-Tone Modulation").



**Setting:**.....  $\phi M$  — Data — rad

**Selection of the modulation source:**.....  $\phi M$  — INT/ON or  $\phi M$  — EXT AC

**Selection of the int. modulation frequency:** ..... Cf. section "AF modulation frequency internal".

**Switching off the  $\phi M$ :** .....  $\phi M$  — OFF

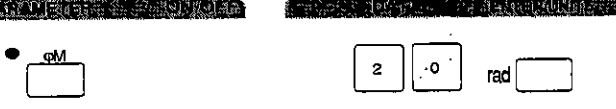
**Switching on the  $\phi M$  without entering a new value to the one stored:**.....  $\phi M$  — INT/ON or  $\phi M$  — EXT AC

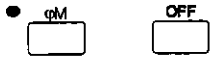
Example	Input	IEC-Bus code
Setting and switching on the $\phi M$ with a deviation of 20 rad		PHM 20RAD
Selection of modulation source INT		PHM:INTERNAL
Switching off the $\phi M$		PHM:OFF

**Display:** 

If  $\phi M$  is switched on, this is indicated, depending on the modulation source, by means of

$\phi M^{EXT}$ ,  $\phi M_{INT}$  or  $\phi M_{INT}^{EXT}$

The phase deviation can be read in 3 digits in the modulation display. The numerical display is common to the deviation with FM or  $\phi M$  and the modulation depth with AM. The value of parameter AM, FM or  $\phi M$  pressed last in the parameter keypad is displayed.

**Associated instructions:** Internal AF modulation frequency  
Modulation, external source  
Two-tone modulation  
Special functions

## 2.16 Modulation, External Source

Modulation inputs AM EXT and FM/φM EXT are available for the modulation fed externally.

For modulations AM and FM, the two modulation inputs can be a.c.-coupled or d.c.-coupled. Selection is effected using keys EXT AC or EXT DC in the parameter keypad.

The input resistances of both inputs are 100 kΩ when the instrument is delivered.

The input resistances can be changed to 600 Ω by means of internal jumpers. The jumpers are on module "processor" for AM and on module "synthesis" for FM/φM.

The pin positions are:

Input resistance	AM module "processor"	FM/φM module "synthesis"
100 kΩ	X501/2-3	X80/1-2
600 Ω	X501/1-2	X80/2-3

A signal of  $V_p = 1 \text{ V}$  ( $V_{rms} = 0.707 \text{ V}$ ) must be applied to achieve the deviation and modulation depth accuracies guaranteed in the data sheet.

Deviations from the required input voltage are indicated in the modulation display by LOW or HIGH.

The display LOW appears for voltages  $V_p \leq 0.97 \text{ V}$ , the display HIGH for voltages  $V_p \geq 1.03 \text{ V}$ . An external voltmeter must be used if higher accuracy is required.

**Associated instructions:**  
 Modulation, AM  
 Modulation, FM  
 Two-tone modulation

## 2.17 Modulation, Two-tone

Two-tone modulation takes place with the signals from the internal modulation source and an external modulation source.

The corresponding special function AM two-tone or FM/φM two-tone must be switched on in order to connect internal and external modulation signals simultaneously.

Modulation is not switched on simply by switching on the special function. Entry of the modulation parameters and switching on and off the modulations must take place exactly as described in the sections on modulation AM, FM or φM. Separate deviation or modulation depth settings for the internal and external modulations are not possible. The required voltage of the external modulation signal is 1 V ( $V_p$ ).

The total deviation or the total modulation depth is equal to twice the value of the one set after value entry.



Ensure that the permissible maximum values for deviation and modulation depth, as listed on the data sheet, are not exceeded.

Switch on/off codes of the two-tone special functions:

Type of modulation	Switch-on	Switch-off
AM two-tone	5	6
FM/φM two-tone	7	8

Example	Input	IEC-bus code
Switching on special function "FM/φM two-tone"		FM:DUAL:AC or FM:DUAL:DC
Switching off special function "FM/φM two-tone"		FM:OFF

#### Associated

**Instructions:** Modulation, (AM, FM/φM)  
Modulation, external source  
Special functions

## 2.18 Variation, Rotary Knob

The rotary knob enables parameters to be increased or decreased in selectable steps. The set parameter (whose LED in the parameter keypad is on) is variable.

RF, AF, LEVEL and the modulation depth with AM and the deviation with FM or φM are variable parameter steps.

A STEP size can be entered for each variable parameter which remains stored when the parameter is changed.

#### Operation:

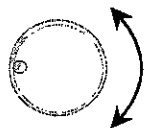

Clockwise rotation increases the value of the parameter set, counter-clockwise rotation decreases it.

**Setting the STEP size:**

Parameter — Step — Data — Unit

The STEP key must be pressed again for each data input. The parameter key need not be pressed first if the parameter has already been set (LED is on).

The smallest step sizes for the various parameters are:

Frequency (RF)	1 Hz
Frequency (AF)	0.1 Hz
Level (RF)	0.1 dB
Modulation depth (AM)	0.1 %
Deviation (FM)	10 Hz
Deviation (φM)	0.001 rad

The STEP size of the level may only be entered in dB even if V, mV or μV is selected as the level unit.

Example	Input	IEC-bus code
Setting an RF step size of 25 kHz	 <p>The diagram shows a control panel with two indicator lights labeled 'RF' and 'STEP'. Below them are two square buttons. To the right is a numeric keypad with buttons for '2', '5', and 'kHz'.</p>	RF:VAR_STEP 25KHZ

**Display:**

A new step size is output in the display of the set parameter until the entry is terminated by the unit key. The set value of the parameter is then displayed.

The step size entered for a parameter can be displayed by pressing the parameter key and then the STEP key.

The step size display is cleared again by pressing a parameter or an ENTER/UNITS key.

## 2.19 Sweep

The SMY provides a digital, step-by-step linear sweep for the RF-frequency (available only with software version 2.0 or higher and with new frontpanel design).

**Start frequency:**..... 5 kHz to 1040 MHz (2080 MHz with SMY02)

**Stop frequency:**..... 5 kHz to 1040 MHz (2080 MHz with SMY02)

**Frequency step:** ..... 1 Hz to 1040 MHz (2080 MHz with SMY02)

**Step time:**..... 10 ms to 5 s

**Resolution:** ..... 1 ms

Example	Input	IEC-bus code
Entry of start frequency	<p>SHIFT <input type="checkbox"/> START <input type="checkbox"/> 7 <input type="checkbox"/> MHz</p>	RF:START
Entry of step time	<p>SHIFT <input type="checkbox"/> TIME/STEP <input type="checkbox"/> 1 <input type="checkbox"/> S</p>	TIME:[RF_SWP]

In the ON mode, the sweep runs from the start frequency to the stop frequency with automatic restart at the start frequency.

The sweep can be stopped by means of the OFF key.

The sweep waits again at the start frequency when the RESET key is pressed.

If the start frequency is larger than the stop frequency, the sweep is performed with negative frequency steps.

The current sweep frequency is indicated in the FREQUENCY display.

The sweep can be stopped by means of the RF key as well. The RF frequency can now be varied. If the RF frequency still lies inside the sweep range, the sweep is continued starting from the current RF frequency upon pressing the ON key.

All other parameters (e. g. level, modulation etc.) can be changed while the sweep is running.

Example	Input	IEC-bus code
Switch on sweep	<p>SHIFT <input type="checkbox"/> ON</p>	SWP:ON or SWP:AUTO
Switch off sweep	<p>SHIFT <input type="checkbox"/> OFF</p>	SWP:OFF
Restart Sweep	<p>SHIFT <input type="checkbox"/> RESET</p>	SWP:RESET

## 2.20 Store - Recall

99 complete instrument settings can be stored. These comprise the complete instrument status including all non-displayed settings and all special functions.

### Storing the current instrument setting:

STO — Memory address — ENTER/UNITS

### Recall of an instrument setting:

RCL — Memory address — ENTER/UNITS

After entering the address, press any ENTER/UNITS key to activate store or recall.

### Values of the memory address:

1 to 99 for STO  
0 to 99 for RCL

Example	Input	IEC-bus code
Storing an instrument setting at memory location 7	<div style="display: flex; justify-content: space-around; align-items: center;"> <div style="border: 1px solid black; padding: 2px;">STO</div> <div style="border: 1px solid black; padding: 2px;">7</div> <div style="border: 1px solid black; width: 30px; height: 20px;"></div> </div>	STORE 7
Storing an instrument setting at memory location 25	<div style="display: flex; justify-content: space-around; align-items: center;"> <div style="border: 1px solid black; padding: 2px;">STO</div> <div style="border: 1px solid black; padding: 2px;">2</div> <div style="border: 1px solid black; padding: 2px;">5</div> <div style="border: 1px solid black; width: 30px; height: 20px;"></div> </div>	STORE 25
Recalling the instrument setting from memory location 7	<div style="display: flex; justify-content: space-around; align-items: center;"> <div style="border: 1px solid black; padding: 2px;">RCL</div> <div style="border: 1px solid black; padding: 2px;">7</div> <div style="border: 1px solid black; width: 30px; height: 20px;"></div> </div>	RECALL 7

Location 0 serves for a special function, i.e. the current instrument setting prior to the last memory or preset recall is stored at this location. This instrument setting can be set again using RCL 0.

Using function SEQ (sequence), the memory settings can be recalled by repeated keying.

**Display:** Reference "MEM" and the memory address are indicated in the modulation display during entry, e.g.:

  
 MEM

**Associated instructions:** Sequence

## 2.21 Sequence

It is possible to recall stored settings in ascending order by repeated keying using the SEQ key in the memory keypad. The same sequencing causes a closure of contacts, as e.g. by means of a foot switch, at the SEQ input (at the rear of the instrument).

The first setting in the sequence of memory calls planned is effected by means of a recall using the RCL key, the setting stored in the next higher memory location is activated by each subsequent keying of the SEQ key or the SEQ input. After the highest memory location number (99), the number of the last RCL call is the one to begin with.

The sequence of the memory addresses starts with 1 if the PRESET key has been actuated before.

Example	Input	IEC-bus code
Recall of memory locations 7, 8, 9 ...		RECALL 7 SEQUENCE SEQUENCE . . .

**Display:** The address of the memory location called last is indicated in the modulation display by the text "MEM" following each actuation of the SEQ key.

**Associated instructions:** Store - recall

## 2.22 Special Functions

The special functions enable settings to be made other than those indicated on the front panel.

The special functions are switched on and off using codes (data input) (see Table 2-1).

All special functions which are switched on are switched off using code 0. All special functions are also switched off by a PRESET.

Example	Input	IEC-bus code
Switching on the special function "Non-interrupting level setting"	<div style="text-align: center; background-color: #cccccc; padding: 2px;">DATA ENTER/UNITS</div> ● SHIFT   ● STEP <input type="checkbox"/> <input type="checkbox"/> SPEC <input type="text" value="1"/> <input type="text"/>	ATTENUATOR:FIXED
Switching off the special function "Non-interrupting level setting"	● SHIFT   ● STEP <input type="checkbox"/> <input type="checkbox"/> SPEC <input type="text" value="2"/> <input type="text"/>	ATTENUATOR:NORMAL
Switching off all special functions	● SHIFT   ● STEP <input type="checkbox"/> <input type="checkbox"/> SPEC <input type="text" value="0"/> <input type="text"/>	

**Display:** The LED of the STATUS key lights up if a special function is switched on. By pressing the status key the code of the special function is output on the FREQUENCY display. If more than one special function is active, the codes are automatically output repeatedly if the STATUS key is pressed continuously or are output one after the other every time the STATUS key is pressed (see section "Status").

Table 2-1 Special functions

Special functions	Code	Remote Control Command
Non-interrupting level setting	1	ATTENUATOR:FIXED
Normal level setting	2	ATTENUATOR:NORMAL
EMF level	3	LEVEL:EMF
Normal level	4	LEVEL
AM two-tone	5	AM:DUAL
AM normal	6	AM
FM/φM two tone	7	FM:DUAL (e.g. FM)
FM/φM normal	8	FM (e.g. FM)
BLANK on	9	BLANK:ON
BLANK off	10	BLANK:OFF
BLANK polarity inverted	11	BLANK:INVERTED
BLANK polarity normal	12	BLANK:NORMAL
ALC bandwidth narrow	13	SPECIAL_FUNCTION 13
ALC bandwidth automatically adapted	14	SPECIAL_FUNCTION 14
ALC bandwidth broad	15	SPECIAL_FUNCTION 15
ALC bandwidth automatically adapted	16	SPECIAL_FUNCTION 16
Set power-on clear flag	17	
Delete power-on clear flag	18	
User request	19	
ALC off	21	SPECIAL_FUNCTION 21
ALC on	22	SPECIAL_FUNCTION 22
AM inverse	23	SPECIAL_FUNCTION 23
AM normal	24	SPECIAL_FUNCTION 24
RF output impedance "open" for LEVEL OFF	25	SPECIAL_FUNCTION 25
RF output impedance 50 Ω for LEVEL OFF	26	SPECIAL_FUNCTION 26
Display of firmware version	29	
Display test	31	SPECIAL_FUNCTION 31
ROM test	33	SPECIAL_FUNCTION 33
RAM test	35	SPECIAL_FUNCTION 35
EEPROM test	37	SPECIAL_FUNCTION 37
Calibrate all	40	SPECIAL_FUNCTION 40
Calibration routine VCO	41	SPECIAL_FUNCTION 41
Calibration routine FM	43	SPECIAL_FUNCTION 43

Table 2-1 Special functions (continued)

Special functions	Code	Remote Control Command
Calibration routine LEVEL PRESET	45	SPECIAL_FUNCTION 45
Calibration RF level on	47	SPECIAL_FUNCTION 47
Terminate calibration of RF level	48	SPECIAL_FUNCTION 48
Level correction off	49	LEVEL:CORRECTION:OFF
Level correction on	50	LEVEL:CORRECTION:ON
Calibration REF-OSC on	51	SPECIAL_FUNCTION 51
Terminate calibration of REF-OSC	52	SPECIAL_FUNCTION 52
FM DC center frequency calibration	55	SPECIAL_FUNCTION 55
Switch off diagnostic test point	100	TEST:OFF
Switch on diagnostic test point	101-116	TEST:POINT 1 (e.g. point 1)

**Explanation of the Individual Special Functions:**

- Non-interrupting level setting:** Non-interrupting level setting is possible in a range of 20 dB. Cf. section "Non-interrupting Level Setting".
- EMF level:** Indication of the EMF voltage. Cf. section "Level EMF".
- AM two tone:** AM with internal and external modulation signal. Cf. section "Two-Tone Modulation".
- FM/φM two tone:** FM or φM with internal and external modulation signal. Cf. section "Two-Tone Modulation".
- BLANK:** Level blanking with an external TTL signal. Cf. section "Pulse Modulation".
- BLANK polarity inverted:** Level blanking with inverted polarity. Cf. section "Pulse Modulation".
- ALC bandwidth ...** The bandwidth of the level control loop can be switched to narrow or broad for special purposes. In normal state, it is adapted automatically.
- Set (delete) power-on clear flag:** Cf. section "Common, Device-Independent Commands" (Table 3-3).
- User request:** When entering the code of this special function, the user triggers a service request via the IEC bus in the LOCAL mode. This service function does not trigger a status indication. Cf. section "Service Request and Status Register".
- ALC off:** The level control is switched to sample and hold operation.
- AM invers:** For positive AM-signal, the RF-level is reduced.
- RF output impedance "OPEN" for LEVEL OFF** When the RF-level is switched off via LEVEL OFF, the RF-output is set to an open impedance.
- Display of firmware version:** The special function indicates the number of the firmware version in the amplitude display.
- Display test:** The special function indicates all display segments. The indication is held as long as one of the four unit keys is pressed.
- ROM test:**
- RAM test:**
- EEPROM test:** The special functions check the data contents. A recognized data error is indicated by a blinking of the status LED and after pressing the status key by means of an error code. Cf. table 2-3, "Status Codes of Errors".



<b>VCO calibration routine:</b>	Self-calibration for the optimal working point of the VCO-PLL. The calibration routine must only be executed in the case of data loss in the RAM or after the exchange of a module.
<b>FM calibration routine:</b>	Self-calibration of the FM. The calibration routine determines correction values to compensate for the fluctuating modulation sensitivity. The routine is to be executed in the case of considerable variations of the temperature, data loss in the RAM or the exchange of a module.
<b>LEVEL PRESET calibration routine:</b>	Self-calibration for the optimal working point of the level control loop. The calibration routine must only be executed in the case of data loss in the RAM or after the exchange of a module.
<b>Calibration RF level:</b>	Permits the input of correction values for the calibrated RF level (see service manual).
<b>Level correction off/on:</b>	Switching on or off level correction (on = default status).
<b>Calibration REF-OSC:</b>	Permits the input of the correction value for the calibrated reference frequency.
<b>FM DC center frequency calibration:</b>	Calibration of the center frequency when FM DC is set.

## 2.23 Self-Test

The SMY carries out a self-test on power-on and permanently during operation.

The RAM and ROM contents are checked when the instrument is switched on. The most important instrument functions are automatically monitored during operation.

A faulty function determined during the self-test is indicated by a flashing of the status LED and by a SERVICE Request message. The status code to identify the error can be output in the modulation display by pressing the STATUS key (see Table 2-3, status codes of errors and overrange/underrange settings in section "Status").

In addition, 16 internal test points can be scanned via the keyboard or the IEC bus and the results read out and displayed in the amplitude display. This more detailed test facility is described in the Service Manual.

## 2.24 Status

The generator produces numerical status messages to identify special functions and errors.

The status codes of special functions are output in the frequency display. The status codes of errors (input or function errors) are output in the modulation display by the test "Err." in the amplitude display.

They can also be scanned via the IEC bus (see section "Error Handling"). The meanings of the status codes are defined in tables 2-2 and 2-3.

**Operation:** The status codes are output in the frequency and modulation displays as long as the STATUS key is pressed. If several status messages are applicable, the codes are automatically output repeatedly if the STATUS key is pressed continuously or are output one after the other every time the STATUS key is stroked.

**Display:** The STATUS LED **lights up continuously** if special functions are switched on or overrange/underrange settings are made.

The STATUS LED **flashes continuously** in the case of function errors.

The STATUS LED **flashes briefly** in the case of input errors.

The status codes of the special functions are output in the frequency display in the following form:

SPECIALS

The code is 0 if no special function is switched on.

The status codes of the function errors and of overrange/underrange settings are output in the amplitude/modulation display in the following form:

Err. 2

The code is 0 if no error is present.

In the case of operator errors, the status codes of the input errors automatically appear briefly in the amplitude/modulation display in the following form:

Err. 51

**IEC bus:** A Service Request message (SRQ) may be output in the case of input and function errors and overrange/underrange settings. The type of error can be recognized from the event status register. An error code can be read out to permit exact error identification.

Table 2-2 Status codes of the special functions

Code	Meaning
0	No special function switched on
1	Non-interrupting level setting
3	EMF level
5	AM two tone
7	FM/φM two tone
9	BLANK on
11	BLANK polarity inverted
13	ALC bandwidth narrow
15	ALC bandwidth broad
21	ALC off
23	AM invers
25	RF output impedance "OPEN"
47	RF level calibration on
49	Level correction off
51	REF-OSC calibration on

Table 2-3 Status codes of errors and overrange/underrange settings

Code	Meaning
0	No error
<b>Function error</b>	
1	10-MHz reference loop out of synchronisation
2	640-MHz loop out of synchronisation
3	Main oscillator loop out of synchronisation
4	Level control not working
5	External overvoltage at the RF output
6	ROM data error
7	RAM data error of the settings stored
8	RAM data error of the VCO correction values
9	RAM data error of the FM correction values
10	RAM data error of the LEVEL PRESET correction values
11	EEPROM data error of the RF level correction values
12	EEPROM data error of the REF OSC correction values
13	EEPROM data error of the option data block
14	EEPROM disfunction
15	Calibration cannot be executed
<b>Input error</b>	
50	Syntax error
51	Value entry without the permissible range
52	Impermissible unit to the parameter selected
53	Impermissible header (IEC bus)
55	Deviation input is too high with the RF set
56	Variation is not possible unless the respective parameter is switched on (IEC bus).
57	FM DC center frequency calibration is only possible when FM DC is set.
<b>Ovrerrange/Underrange Settings</b>	
70	AM not specified with the level set
71	AM not specified for AF > 50 kHz
72	RF < 9 kHz
73	AM EXT signal out of tolerance
74	FM/φM EXT signal out of tolerance
75	φM not specified for AF < 20 Hz or AF > 20 kHz
76	AF > 500 kHz
77	Level > 13 dBm (> 19 dBm with option SMY-B40)
78	OVEN COLD
81	ALC WIDE is not allowed (with option SMY-B40 at level >19 dBm)
82	TIME/STEP is too small

## 2.25 Instrument Preset

The instrument is set to a defined basic status by pressing the key PRESET.

Table 2-4 Preset status

	Setting
Reference frequency	internal
RF	100 MHz
Amplitude	-30 dBm
Parameter set	RF
Modulation	switched off
AF	switched off
Special functions	switched off
Status and mask registers of the service request functions	unchanged
IEC-bus address	unchanged

	Preset to
RF step	1 MHz
Amplitude, step	0.1 dB
AF	1 kHz
AF step	0.1 kHz
AM modulation depth	30 %
AM step	1 %
FM deviation	10 kHz
FM step	1 kHz
$\phi$ M deviation	1 rad
$\phi$ M step	0.1 rad
Memory locations	unchanged

## 2.26 IEC-Bus Address

The IEC-bus address can be displayed and set using the keys. It is stored until overwritten by a new address. The address range is from 0 to 30. The SMY is set to address 28 on delivery.

Example	Input	IEC-bus code
Output IEC-bus address on display  Set IEC-bus address 7	  LOC/IEC ADD <input data-bbox="596 584 670 627" type="text"/>  LOC/IEC ADD <input data-bbox="596 676 670 720" type="text"/> 7 <input data-bbox="1037 676 1111 720" type="text"/>	

**Display:** The IEC-bus address is output in the frequency display which is cleared by pressing any one of the parameter keys or the ENTER/UNITS keys.

### 3 Remote Control of Instrument via IEC Bus

The SMY is fitted with an IEC-bus interface as a standard. The interface corresponds to the IEC 625-1/IEEE 488/1 standard.

In addition, standard IEC 625-2/IEEE 488.2 (IEEE standard codes, formats, protocols and common commands) has been considered. This includes a description of the data transmission formats and common commands.

The command set of the SMY is upward compatible with SMX, SMG, SMH, SMGU and SMHU (as far as the instruments have comparable functions).

#### 3.1 Brief Instructions for Simple Applications

- Connect controller and SMY using the IEC bus cable.
- Set device address 28 on the SMY:

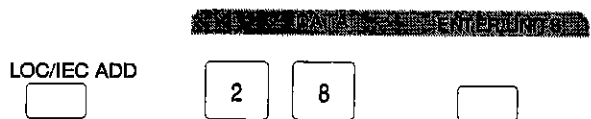

- Device settings (examples)

The first command sent via the IEC bus interface sets the SMY to the remote status indicated by the REMOTE LED being illuminated.

BASIC command (Rohde & Schwarz BASIC)	Effect on the SMY
IECOUT 28, "**RST"	Instrument in basic status
IECOUT 28, "RF 155.623458MHZ"	Frequency (RF) is set
IECOUT 28, "LEVEL -11.5DBM"	Level (into 50 Ω) is set
IECOUT 28, "AF 12.5KHZ; FM:INT 40KHZ"	Modulation frequency (AF) and internal frequency modulation are set.

- Following actuation of the LOC/IEC ADD key, the SMY abandons the remote status and is ready for manual operation again.

#### 3.2 Setting the Device Address

In the LOCAL mode (REMOTE LED off), the IEC bus address can be displayed and set using key LOC/IEC ADD (cf. the page preceding as well). The IEC bus address remains stored also at power-off of the instrument. The address range covers 0 to 30. The instrument is factory-set to address 28.

The address is the decimal equivalent of bits 1 to 5 of the talker or listener address. This form is also used for the IEC bus commands of the controllers.

### 3.3 Device Messages

Device messages are transmitted on the data lines of the IEC bus, with the attention line being High (not active). The ASCII code (ISO 7-bit code) is used (cf. Table 3-8).

- The messages from the controller to the SMY (programming messages) are referred to as commands in the following.

They include the following four groups:

- \* Device-specific setting commands
- \* Device-specific data request commands
- \* Common, device-independent setting commands (Common commands in accordance with IEEE 488.2)
- \* Common, device-independent data request commands (Common queries in accordance with IEEE 488.2)

The tables listed in the following specify all these commands. Their respective syntax is described in section 3.3.6.

- The messages from the SMY to the controller (response messages) are specified in combination with their associated data request commands. As to their syntax, refer to section 3.3.7.

#### 3.3.1 Device-specific Setting Commands

All the instrument functions to be set via the SMY keyboard can also be obtained via the IEC bus. The instrument performance initiated via setting commands fully corresponds to that obtained by keyboard entries.

The shortest notation possible is shown in bold print.

Table 3-1

Header	Numeric Value	Permissible Units	Default Unit	Explanation
<b>AF</b>	Value	HZ KHZ MHZ	Hz	Modulation frequency
<b>AF:VAR_STEP</b>	Value	HZ KHZ MHZ	Hz	AF variation step width
<b>AF:ON</b>	-	-	-	Switch on AF to stored value <sup>1)</sup>
<b>AF:OFF</b>	-	-	-	Switch off AF <sup>1)</sup>
<b>ALC:AUTO</b>	-	-	-	Select level control bandwidth automatically
<b>ALC:FIXED</b>	-	-	-	Switch off level control
<b>ALC:NARROW</b>	-	-	-	Level control bandwidth is narrow
<b>ALC:NORMAL</b>	-	-	-	Switch on level control
<b>ALC:WIDE</b>	-	-	-	Level control bandwidth is wide
<b>AM</b> <b>AM:INTERNAL</b> <b>AM:EXTERNAL:AC</b> <b>AM:EXTERNAL:DC</b>	Value	PCT	PCT (%)	Switch on AM with modulation source selected and set modulation depth <sup>2)</sup>

Header	Numeric Value	Permissible Units	Default Unit	Explanation
<b>AM:INTERNAL</b> <b>AM:EXTERNAL:AC</b> <b>AM:EXTERNAL:DC</b>	-	-	-	As above, but set stored value of modulation depth
<b>AM:DUAL:AC</b> <b>AM:DUAL:DC</b>	Value	PCT	PCT (%)	Switch on two-tone AM with internal and external source and set modulation depth
<b>AM:DUAL:AC</b> <b>AM:DUAL:DC</b>	-	-	-	As above, but set stored value of the modulation depth.
<b>AM:OFF</b>	-	-	-	Switch off AM
<b>AM:VAR_STEP</b>	Value	PCT	PCT (%)	Variation step width of AM modulation depth
<b>ATTENUATOR:FIXED</b>	-	-	-	Non-interrupting level setting (Switch on special function 1)
<b>ATTENUATOR:NORMAL</b>	-	-	-	Normal level setting function (switch off special function 1)
<b>BLANK:ON</b> <b>BLANK:OFF</b>	-	-	-	Level blanking (pulse modulation) on Level blanking (pulse modulation) off
<b>BLANK:INVERTED</b> <b>BLANK:NORMAL</b>	-	-	-	BLANK polarity inverted BLANK polarity normal
<b>DECREMENT:AF</b> <b>DECREMENT:AM</b> <b>DECREMENT:FM</b> <b>DECREMENT:LEVEL</b> <b>DECREMENT:PHM</b> <b>DECREMENT:RF</b>	-	-	-	Corresponds to variation using the rotary knob. Entry of step width using VAR_STEP for the respective parameter.
<b>FM</b> <b>FM:INTERNAL</b> <b>FM:EXTERNAL:AC</b> <b>FM:EXTERNAL:DC</b>	Value	HZ KHZ MHZ	Hz	Switch on FM with modulation source selected and set FM deviation 3)
<b>FM:INTERNAL</b> <b>FM:EXTERNAL:AC</b> <b>FM:EXTERNAL:DC</b>	-	-	-	As above, but set stored value of deviation
<b>FM:DUAL:AC</b> <b>FM:DUAL:DC</b>	Value	HZ KHZ MHZ	Hz	Switch on two-tone FM with external and internal source and set deviation.
<b>FM:DUAL:AC</b> <b>FM:DUAL:DC</b>	-	-	-	As above, but set stored value of the deviation.
<b>FM:OFF</b>	-	-	-	Switch off FM



Header	Numeric Value	Permissible Units	Default Unit	Explanation
<b>FM:VAR_STEP</b>	Value	HZ KHZ MHZ	Hz	Variation step width of FM deviation
<b>HEADER:ON</b> <sup>5)</sup> <b>HEADER:OFF</b>	- -	- -	- -	Messages from the SMY to the controller are sent with or without header
<b>INCREMENT:AF</b> <b>INCREMENT:AM</b> <b>INCREMENT:FM</b> <b>INCREMENT:LEVEL</b> <b>INCREMENT:PHM</b> <b>INCREMENT:RF</b>	-	-	-	Corresponds to rotary knob variation. Entry of step width with VAR_STEP for each parameter.
<b>LEVEL</b>	Value	DBM DBUV V MV UV	dBm	Level
<b>LEVEL:EMF</b>	Value	DBUV V MV UV	dB $\mu$ V	Level EMF
<b>LEVEL:VAR_STEP</b>	Value	DB	dB	Variation step width of the level
<b>LEVEL:OFF</b>	-	-	-	Switch off output signal
<b>LEVEL:ON</b>	-	-	-	Switch on output signal to stored value of level again
<b>LEVEL:CORRECT_INDEX</b>	Value	-	-	Level correction: Select correction value index, associated frequency is set (see Service Manual)
<b>LEVEL:CORRECTION</b>	Value	DB	dB	Entering correction value and storing it (see Service Manual)
<b>LEVEL:CORRECTION:ON</b> <b>LEVEL:CORRECTION:OFF</b>	- -	- -	- -	Special function: Level Correction on/off
<b>PHM:</b> <b>PHM:INTERNAL</b> <b>PHM:EXTERNAL</b>	Value	RAD	RAD	Switch on phase modulation with modulation source selected and set FM deviation. 3)
<b>PHM:INTERNAL</b> <b>PHM:EXTERNAL</b>	- -	- -	- -	As above, but set stored value of the deviation.
<b>PHM:DUAL</b>	Value	RAD	RAD	Switch on two-tone phase modulation with internal and external source and set deviation.
<b>PHM:DUAL</b>	-	-	-	As above, but set stored value of the deviation.
<b>PHM:VAR_STEP</b>	Value	RAD	RAD	Variation step width of the PHM deviation
<b>PHM:OFF</b>	-	-	-	Switch off phase modulation
<b>PRESET</b>	-	-	-	Set device to basic status (see Section "Instrument Preset")

Header	Numeric Value	Permissible Units	Default Unit	Explanation
<b>RECALL</b>	Value	-	-	Call a stored device setting (same effect as *RCL)
<b>REFERENCE_OSCILLATOR: CORRECTION</b>	Value	-	-	Enter correction value for internal reference frequency
<b>REFERENCE_OSCILLATOR: CORRECTION:STORE</b>	-	-	-	Store correction value for internal reference frequency
<b>REFERENCE_OSCILLATOR:INTERNAL</b>	-	-	-	Internal reference frequency
<b>REFERENCE_OSCILLATOR:EXTERNAL</b>	-	-	-	External reference frequency
<b>RF</b>	Value	HZ KHZ MHZ GHZ	Hz	Frequency
<b>RF:START</b> <b>:STOP</b> <b>:STEP</b>	Value		Hz kHz MHz GHz	Start frequency for RF-sweep Stop frequency for RF-sweep Step size for linear sweep
<b>RF:VAR_STEP</b>	Value	HZ KHZ MHZ	Hz	Variation step width of the frequency
<b>SEQUENCE</b>	-	-	-	Sequence of stored device settings 4)
<b>SPECIAL_FUNCTION</b>	Value	-	-	Switching on/off a special function by means of the respective code (see Table 2-1)
<b>STORE</b>	Value	-	-	Store device setting (same effect as *SAV)
<b>SWP:ON</b> <b>:AUTO</b> <b>:RESET</b> <b>:OFF</b>				Switch on sweep  Switch off sweep
<b>TALK_TERMINATOR:NL_END</b> 5)	-	-	-	Terminator in talk mode:
<b>TALK_TERMINATOR:CR_NL_END</b>	-	-	-	New Line + End or Carriage Return + New Line + End
<b>TEST:POINT</b>	Value	-	-	Selection of an internal test point (1 to 16) to measure the test voltage. Switches on special function "Diagnostic Test Point" (see Service Manual).
<b>TEST:OFF</b>	-	-	-	Switches off special function "Diagnostic Test Point"
<b>TIME[:RF_SWP]</b>	Value	-	s ms	Step time for selected sweep mode

1) These commands are only required if the AF output (connector AF INT) is to be used.

2) If the modulation source (INTERNAL, EXTERNAL or DUAL) is not specified,  
- selection is internal if AM was not switched on before,  
- the previous source is retained unchanged if AM was switched on.

3) If the modulation source (INTERNAL, EXTERNAL or DUAL) is not specified,  
- selection is internal if FM/PHM was not switched on before,  
- the previous source is retained unchanged if FM/PHM was switched on.

4) The 1st memory location in the sequence is defined by the \*RCL command.  
Example: Command sequence: \*RCL 47 SEQ SEQ SEQ SEQ ...  
Memory location: 47 48 49 50 47 ...

5) Default setting following switch-on of operating voltage or command \*RST.

### 3.3.2 Device-specific Data Request Commands and Messages Sent by the SMY

Table 3-2

Data Request (The shortest-possible notation is marked by bold print)	Message the SMY sends in talker mode							Unit (is not sent)	Explanation
	Header	Numeric value			Exponent	Example	-		
		Number of signs	Polarity sign	Decimal point					
<b>AF?</b>	AF	8	-	x	x	15.0E+3 ↑	-	Hz	Modulation frequency
<b>AF:VAR_STEP?</b>	AF:VAR	6	-	-	-	25 ↑↑↑↑	-	Hz	AF variation step width
<b>ALC?</b>	ALC:AUTO:NOR	8	-	-	-	-	-	-	State of the level control loop
	ALC:NARR:NOR	8	-	-	-	-	-	-	
	ALC:WIDENOR	8	-	-	-	-	-	-	
	ALC:AUTO:FIX	8	-	-	-	-	-	-	
	ALC:NARR:FIX	8	-	-	-	-	-	-	
	ALC:WIDE:FIX	8	-	-	-	-	-	-	
<b>AM?</b>	AM:INT	4	-	x	x	37.5	-	PCT (%)	AM modulation depth
	AM:E:A	4	-	x	x	18.0	-	PCT (%)	
	AM:E:D	4	-	x	x	33.5	-	PCT (%)	
	AM:D:A	4	-	x	x	99.0	-	PCT (%)	
	AM:D:D	4	-	x	x	1.0	-	PCT (%)	
	AM:OFF	0	-	-	-	↑	-	-	
<b>AM:VAR_STEP?</b>	AM:VAR	4	-	x	x	10.0	-	PCT (%)	Variation step width of AM modulation depth
<b>ATTENUATOR?</b>	ATT:FIX	0	-	-	-	-	-	-	Special function "Non-interrupting level setting" is switched on (FIX) or off (NOR)
	ATT:NOR	0	-	-	-	-	-	-	
<b>ATTEN:CONT?</b>	ATT:CONT	4	-	x	x	8.5	-	dB	Electronic distortion with ATT:FIX no numerical value with ATT:NOR
	ATT:NOR	0	-	-	-	↑	-	-	

Data Request (The shortest-possible notation is marked by bold print)	Message the SMY sends in talker mode							Unit (is not sent)	Explanation
	Header	Numeric value					Example		
		Number of signs	Polarity sign	Decimal point	Exponent	Example			
<b>ERRORS?</b>		2 per value	-	-	-	-	0 ↑ 4, 5, 51 ↑	-	Error codes, max. 13 error codes, 0 means no errors (see Table and Section "Error Handling") 1)
<b>FM?</b>	FM:INT FM:E:A FM:E:D FM:D:A FM:D:D FM:OFF	8 8 8 8 8 0	- - - - - -	X X X X X -	X X X X X -	X X X X X -	13.50E+3 0.800E+3 1.250E+3 10.00E+6 1.500E+6 -*)	Hz Hz Hz Hz Hz -	FM deviation
<b>FM:VAR_STEP?</b>	FM:VAR	8	-	X	X	X	0.100E+3	Hz	Variation step width of FM deviation
<b>LEVEL?</b>	LEVEL LEVEL:OFF	6 0	X -	X X	X X	- -	-105.3 -*)	dBm -	Level
<b>LEVEL:CORRECT_INDEX?</b>	LEVEL: CORRECT_INDEX	3					38 ↑	-	Index of the level correction value
<b>LEVEL:CORRECTION?</b>	LEVEL: CORRECTION	6	X	X	X	-	+1.26 ↑	dB	Level correction value
<b>LEVEL:EMF?</b>	LEVEL:EMF LEVEL:OFF	6 0	X -	X -	X -	- -	+120.0 -*)	dBµV	Level as EMF
<b>LEVEL:VAR_STEP?</b>	LEVEL:VAR	5	-	X	X	-	20.0 ↑	dB	Variation step width of level
<b>PHM?</b>	PHM:INT PHM:EXT PHM:DUA PHM:OFF	8 8 8 0	- - - -	X X X -	X X X -	X X X -	1.000E+0 0.050E+0 100.0E+0 -*)	RAD RAD RAD -	Deviation of phase modulation
<b>REFERENCE_OSCILLATOR?</b>	REF:INT REF:EXT	0 0	- -	- -	- -	- -	- -	- -	Reference frequency internal or external
<b>REFERENCE_OSCILLATOR: CORRECTION?</b>	REFERENCE_ OSCILLATOR: CORRECTION	1 to 4							Correction value for reference frequency

Data Request (The shortest-possible notation is marked by bold print)	Message the SMY sends in talker mode							Unit (is not sent)	Explanation
	Header	Numeric value							
		Number of signs	Polarity sign	Decimal point	Exponent	Example			
<b>RF?</b>	RF	14	-	x	x	x	1000.000000E+6	Hz	Frequency
<b>RF:START?</b>	RF	14	-	x	x	x	1000.000000E+6	Hz	Start frequency
<b>RF:STOP?</b>	RF	14	-	x	x	x	1000.000000E+6	Hz	Stop frequency
<b>RF:STEP?</b>	RF	14	-	x	x	x	1000.000000E+6	Hz	Step width
<b>RF:VAR_STEP?</b>	RF:VAR	14	-	x	x	x	2500.00E+3 ↑↑↑	Hz	Variation step width of frequency
<b>SPECIAL_FUNCTION?</b>	SPECIAL	3 per value	-	-	-	-	0 1, 5, 112, ↑↑ ↑↑	-	Codes of special functions switched on; 0 means no special function 1)
<b>SWP?</b>	RF	14	-	x	x	x	OFF	-	Query of sweep mode (AUTO/OFF/RESET)
<b>TEST:POINT?</b>	TEST:POINT TEST:OFF	2 0	- -	- -	- -	- -	15 *)	- -	Test point
<b>TEST:VOLTAGE?</b>	TEST:VOLT TEST:OFF	6 0	x -	x -	x -	- -	+4.51 ↑ *)	V -	Voltage at internal test points (see service manual)
<b>TIME:RF_SWP?</b>	RF	14	-	x	x	x	1000.000000E+6	s	Step time

1) With these commands, the message from the SMY can contain several numeric values, they are separated from one another by means of commas (,).  
The number of characters indicated refers to one numeric value each.

Notes:  
x means present  
- means not present  
↑ means Space  
\*) A number is not transmitted with OFF; with the header switched off, only the delimiter or terminator appears.

### 3.3.3 Common, Device-independent Setting Commands (Common Commands in Accordance with IEEE 488.2)

Table 3-3

Command	Number, range	Meaning
*CLS	-	<p>Clear Status</p> <p>Sets the Event Status Register (ESR) to zero. The mask registers of the Service Request function (ESE and SRE) are not changed.</p> <p>A current Service Request message is only reset if not caused by a message in the output buffer or if *CLS is at the start of a command line. *)</p>
*ESE	0 ... 255	<p>Event Status Enable</p> <p>The Event Status Enable mask register is set to the specified value interpreted as a decimal number ).</p>
*HDR	0 or 1	<p>Header</p> <p>"0" suppresses the header in the device response to future queries. The numeric value is read out exclusively. The command is equivalent to the command HEADER:OFF:</p> <p>"1" activates the header in the device response to future queries. The device response can be reused as a setting command. The command is equivalent to the command HEADER:ON:</p>
*OPC	-	<p>Operation Complete</p> <p>Sets bit 0 (Operation Complete) in the Event Status register if all previous commands have been processed (see Section "Timing of command Processing and Synchronization").</p>
*PSC	0 or 1	<p>Power On Clear Flag</p> <p>If 1: The Service Request Enable mask register (SRE) and the Event Status Enable mask register (ESE) are also cleared when the instrument is switched on.</p> <p>If 0: The above-mentioned registers retain their contents even when the instrument is switched off and on. This enables a Service Request when the instrument is switched on.</p> <p>The Power On Clear Flag can be set with special function 17 and cleared with special function 18 (manual operation).</p>
*RCL	0 ... 50	<p>Recall</p> <p>Call a stored instrument setting (cf. Section "Store-Recall")</p>
*RST	-	<p>Reset</p> <p>Acts like the PRESET key (see Section "Instrument Preset") and            → switches to messages with header (like command HEADER:ON),            → sets the terminator in talker mode to "NEW Line + End",</p> <p>Does not change the status of the IEC-bus interface, the set IEC-bus address, and the registers of the Service Request function.</p>
*SAV	1 ... 50	<p>Save</p> <p>Store instrument setting (cf. Section "Store-Recall")</p>
*SRE	0 ... 255	<p>Service Request Enable</p> <p>The Service Request Enable mask register is set to the specified value interpreted as a decimal number ).</p>
*WAI	-	<p>Wait to Continue</p> <p>Interrupts command processing until all preceding commands have been executed (cf. Section "Command Processing Sequence and Synchronization")</p>

\*) See section "Service Request and Status Register"

### 3.3.4 Common, Device-independent Data Request Commands (Common Queries in Accordance with IEEE 488.2)

Table 3-4

Data request command	Message read out			Meaning
	Header	Data value		
		Digit number	Range	
*ESE?	*ESE	3	0...255	Event Status Enable Query The contents of the Event Status Enable mask register is output in decimal.
*ESR?	*ESR	3	0...255	Event Status Register Query The contents of the Event Status Register is output in decimal and the register is then set to zero.
*IDN?	-	26	(alpha-numeric)	Identification Query The following identification text is transmitted via the IEC bus (always without header) as a reply to the command *IDN? ROHDE&SCHWARZ, SMY01, 0, 1.00  <div style="display: flex; justify-content: space-around; align-items: center;"> <div style="text-align: center;">                            Manufacturer         </div> <div style="text-align: center;">                            Model         </div> <div style="text-align: center;">                            Firmware release (example)         </div> </div> <div style="text-align: center;">                            Serial number         </div>
*HDR?	-	1	0 or 1	Header Query This command returns the current state of the header setting.
*OPC?	*OPC	1	1	Operation Complete Query Message "*OPC 1" or only "1" (depending on the status of the header flag) is entered into the output buffer and bit 4 (message available) in the status byte is set if all previous commands have been processed (see Section "Timing of Command Processing and Synchronization").
*OPT?	-	1...2	(alpha-numeric)	Option Query Transmits information on an option possibly fitted via the IEC bus (always without header). B1: If option SMY-B1, Reference Oscillator, is fitted. 0: If no option is fitted.
*PSC?	*PSC	1	0 or 1	Power On Clear Query To read the status of the Power On Clear Flag, see *PSC in Table 3-3
*SRE?	*SRE	3	0...255	Service Request Enable Query The contents of the Service Request Enable mask register is output in decimal.
*STB?	*STB	3	0...255	Status Byte Query The contents of the status byte is output in decimal.
*TST?	*TST	2	0...67	Self-test Query A ROM, EEPROM and RAM test is performed. The result can be obtained from the data value of the output message: 0: no error 6: ROM error 7: RAM error 8: EEPROM error Example with several errors: 67: ROM and RAM error

### 3.3.5 Examples

(The Rohde & Schwarz BASIC commands have been used. The IEC bus address of the SMY has been taken to be 28).

#### 1) Basic setting

```
IECOUT 28, "*RST"      or
IECOUT 28, "PRESET"
```

#### 2) Device identification via IEC bus:

```
10 IECTERM 10           (input terminator: new line)
20 IECOUT 28, "**IDN?"
30 IECIN 28, A$
40 PRINT A$
```

#### 3) RF setting

```
IECOUT 28, "RF 123.456MHz"  or
IECOUT 28, "RF 123.456E6"   or
IECOUT 28, "RF 123456000"
```

#### 4) RF level setting

All the possibilities as outlined effectuate the same setting.

```
IECOUT 28, "LEVEL 12.5DBM"  or
IECOUT 28, "LEV 12.5"      or
IECOUT 28, "LEVEL 119.5DBUV" or
IECOUT 28, "LEVEL 0.944V"  or
IECOUT 28, "Level 944mV"   or
IECOUT 28, "LEVEL 944MV"   or
IECOUT 28, "LEVEL:EMF 1.888V"
```

#### 5) Non-interrupting variation of RF level between 2 $\mu$ V and 20 $\mu$ V in steps of 0.2 dB; stop at each step for 10 ms

```
10 IECOUT 28, "LEVEL 20uV; ATTN:FIXED; LEVEL 2uV; LEVEL:VAR 0.2"
20 FOR I% = 1 TO 100
30 IECOUT 28, "INCREMENT:LEVEL"
40 HOLD 10
50 NEXT I%
```

#### 6) Modulation frequency (AF) and internal frequency modulation setting

```
IECOUT 28, "AF 12.5KHZ; FM:INT 40KHZ"
```

#### 7) External amplitude modulation setting (AC coupling)

```
IECOUT 28, "AM:EXT:AC 35.5"
```

#### 8) Storing complete instrument setting in memory location 45

```
IECOUT 28, "**SAV 45"
```

#### 9) Switching off the modulation again

```
IECOUT 28, "FM:OFF; AM:OFF"
```





Since the carriage return character (ASCII code 13 decimal) is permissible as an ineffectual filler before the terminator, also the combination of carriage return + new line is permissible.

A command line may require more than one line on the screen of the controller because it is only limited by the terminator. Most IEC bus controllers automatically append the terminator to the useful text.

Also, a command line may contain several commands (program message units) to be separated by semicolons (;).

The possibility of abbreviation described in IEC 625-2/IEEE 488.2 with several commands in one line,

**Example:** :TEST:POINT 11; :TEST:VOLTAGE?

abbreviated as

:TEST:POINT 11; VOLTAGE?

is not possible with the SMY.

A command may consist of the following parts:

- Header only

**Example:** FM:OFF

- Header and question mark

**Example:** FM?

This combination requests the SMY to provide the required data in an output buffer in order to have them transferred via the IEC bus as soon as the SMY has been addressed as a talker.

- Header and number

**Example:** FM 55E3 or FM 55 kHz

Header and number are to be separated by at least one space (ASCII-Code 32 decimal). In the case of device-specific commands, the number can be supplemented by a subsequent unit.

Lower-case letters are permissible, being equivalent to the corresponding upper-case letters. Thus, units can be used in the usual form (e.g. dBm) instead of the upper-case notation (e.g. DBM), which is permissible as well.

Additional spaces may be inserted at the following positions:

- before a header,
- between header and number,
- between mantissa and exponent of the number,
- between number and unit,
- before and after a comma (,) and semicolon (;),
- before the terminator.

## Headers of device-specific commands

The headers are mostly identical with or similar to the respective key designation, which results in easy-to-read (self-documenting) programs.

Two equivalent command notations are possible for special functions:

- Header 'SPECIAL\_FUNCTION' and special function code (as with manual operation)

**Example:** SPECIAL 1;

- Special commands with higher documentation value for each individual special function

**Example:** ATTENUATOR:FIXED,

Some special functions (two-tone modulation, level emf) have no meaning in IEC bus operation. The appropriate settings are directly selected in the respective commands:

AM:DUAL:AC, FM:DUAL:DC, PHM:DUAL, LEVEL:EMF

The headers can be abbreviated at will by omitting characters at the end (e.g.: LE or LEV instead of LEVEL). The shortest-possible notations are shown in the command tables in bold print. However, so as to obtain easy-to-read programs, the headers should not be shortened too much.

Many headers consist of several parts separated by colons (:) (e.g.: "ATTENUATOR:FIXED"). Each part of the header may individually be abbreviated in this case (e.g.: "ATT:F"). According to IEEE 488.2 standard, these headers may also comprise a leading colon (e.g.: ":ATT:F") which, however, does not influence the effects of the commands with the SMY.

Some headers include the underline character (ASCII code 95 decimal) to improve readability. It must be written like the letters, but always lies in the range that can be omitted by abbreviation <sup>1)</sup>.

## Numeric value

Only decimal values are allowed as numbers, the following notations being permissible:

- With or without polarity sign  
e.g. 5, +5, -5
- With or without decimal point, any position of the decimal point being permissible.  
e.g. 1.234, -100.5, .327
- With or without exponent to base 10, "E" or "e" are used as the exponent character.  
e.g. .451, 451E-3, +4.51e-2

Note: Specification of the exponent alone (e.g.: E-3) is not permissible, 1E-3 is correct.

- The exponent is permissible with or without sign, additional spaces are also permissible.  
e.g. 1.5E+3, 1.5E-3, 1.5E3
- Leading zeroes are permissible in mantissa and exponent.  
e.g. +0001.5, -01.5E-03

<sup>1)</sup> The underline character is generated using the "←" key with R&S controllers PCA and PUC.

- The length of the number, including the exponent, may amount to up to 20 characters. The number of digits of the mantissa and exponent is only limited by this condition. Digits which exceed the resolution of the device are rounded up or down; they are always considered for the order of magnitude (power of ten).  
e.g. 150000000, 0.00000032

All setting commands that can be assigned a number are indicated in the number column in Table 3-1.

### Unit

Device-specific setting commands permit to append a unit to the number (e.g.: 125.3 kHz or 125.3E3 Hz). The permissible units are listed in Table 3-1 (table of device-specific setting commands). They can be written in lower-case or upper-case letters. If no unit is used, the default unit is valid, see Table 3-1.

### 3.3.7 Data Request and Syntax of the Messages Sent by the SMY to the Controller (Response Messages)

The SMY transmits messages via the IEC bus if it:

- 1) has been requested by one or several <sup>1)</sup> data requests with a question mark (query messages) to provide data in its output buffer, and
- 2) indicates by setting bit 4 in the status byte (MAV - message available) that the required data are now present in the output buffer (see also Section "Service Request and Status Register") and
- 3) has been addressed as a talker  
(BASIC command "IECIN adr, stringvariable")

It must be noted that the command line with the data requests must be transmitted immediately before the talker is addressed; the output buffer is cleared if a further command line is entered in between.

If the SMY is immediately addressed as a talker following the data request without observing point 2 above, the bus handshake is blocked until the requested data are available. This method is meaningful with the SMY since only a few milliseconds are required to execute a data request (see the following program example).

#### Program example:

Read current frequency (R&S BASIC; address of the SMY: 28).

10	IECTERM 10	Input terminator: new line
20	IECOUT 28, "HEADER:ON"	Set messages with header
30	IECOUT 28, "RF?"	Data request RF frequency
40	IECIN 28, F\$	Reading talker addressing and data
50	PRINT F\$	RF frequency indicated on controller, e.g.: "RF 1000.000000E+6"

<sup>1)</sup> Several data requests must be within one command line if the SMY is to transmit all the relevant messages at a time.

The syntax of messages sent by the SMY is shown in Fig. 3-2. The syntax is similar to that for commands received by the SMY.

### Output message line

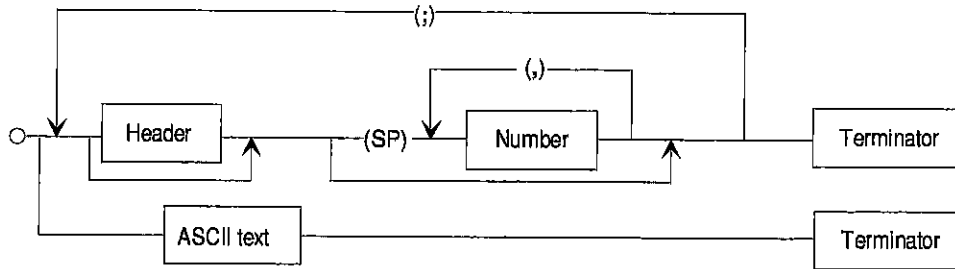

### Number

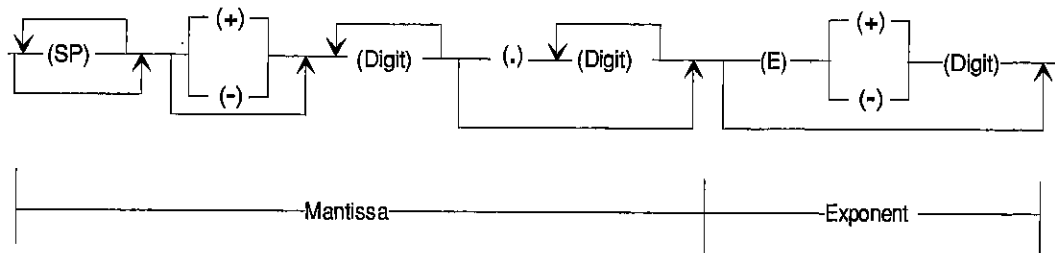

**SP:** Space (ASCII code 32 decimal)

**ASCII text:** Response to commands \*IDN? and \*OPT? (cf. Table 2-10)

Fig. 3-2 Syntax diagram of the messages sent by the SMY

- \* New line (ASCII code 10 decimal) together with End (EOI line active) is used as the terminator. It is also possible to set Carriage return + new line + end (using command TALK\_TERMINATOR:CR\_NL\_END).
- \* Commands "HEADER:ON" or "HEADER:OFF" can be used to select whether only the numbers or the header and the numbers are to be transmitted.

The setting "Header and numbers" can also be selected by

- > the command \*RST (reset) or
- > by switching on the operating voltage.

The setting "Header and numbers" enables the messages transmitted by the SMY to be returned to the SMY as unmodified commands. It is then possible to read a setting entered via the keyboard, store it in the controller and repeat it later via the IEC bus.

- \* If the SMY receives several data requests, it also returns several messages within one line which are separated by semicolons (;).
- \* Headers and numbers are always separated by a space.
- \* The headers only consist of upper-case letters and the characters ":".
- \* The syntax of the numeric values is described in Fig. 3-2. Only decimal numbers are transmitted. The length of the numbers and examples for each message can be taken from Tables 3-2 and 3-3.

- \* Several numbers can be transmitted in response to the commands SPECIAL\_FUNCTION? and ERRORS?, which are separated by commas (,).
- \* The messages sent by the SMY contain no units. In the case of physical quantities, the numbers are referred to the basic unit specified in Table 3.2.

### 3.3.8 Alternative Commands and Notations

To obtain a high degree of compatibility with regard to Rohde & Schwarz instruments of earlier production dates, the SMY features alternative commands and also accepts notations of a different syntax. The following table specifies both possibilities with the SMY, which are identical as to their effect.

Table 3-5

Preferred notation (in accordance with IEEE 488.2)	Alternative notation
*SAV value *RCL value	STORE value RECALL value
HEADER:ON HEADER:OFF	*HDR 1 *HDR 0
Unit percent: PCT	%
Write units as indicated in the command tables	Units may be abbreviated like headers: Hz, KHz, MHz, GHz, PCT, V, MV, UV, DBM, DBUV, DB, RAD
Delimiter between commands: semicolon (;)	Comma (,)
Delimiter between header and numeric value: space	No delimiter necessary

### 3.3.9 Multiple Settings

If several IEC-bus commands are sent in a line, they will be executed in the logically correct sequence, but the modules are not activated until the end of the line when the shape of the output signal has been determined. The modules are set in the optimal sequence with regard to the best possible overlapping of the possible wait times, and the output signal switches to the desired state. This method avoids signal interference and saves setting time.

The following example shows this (Rohde&Schwarz BASIC):

```
IEC OUT 28, "*RST"  
IEC OUT 28, "LEVEL 0DBM; RF 500MHZ; AM:EXT 50; FM:INT 50KHZ"
```

After the PRESET setting, the SMY next processes the entire line without affecting the output signal. Contrary to the order in the command line, the synthesizer is set first due to its settling time (the synthesizer's RF and FM are set at the same time). After the AF generator, the output section is set, whereby the level correction for the changed frequency, the new level and the activated AM are taken care of in one computer run.

The computing times for the AF generator and the output section, as well as the wait times due to the switching attenuator, overlap completely with the settling time of the synthesizer. The total setting time corresponds to the setting time of the slowest parameter, which in this case is the RF.

In a similar way, the level of the instrument can be varied:

```
IEC OUT 28, "LEVEL 10DBM; ATTEN:FIX; LEVEL 0DBM"
```

When this line has been processed, the SMY directly outputs a level of 0 dBm with non-interrupting setting possibilities up to +10 dBm, without a level of 10 dBm first being present at the output.

If desired, the hardware setting can be forced in a command line with \*wai or \*opc.

### 3.4 Interface Messages

Interface messages (according to IEC 625-1 and IEEE 488 standard) are transmitted to the SMY on the data lines with the attention line being active (Low).

#### 3.4.1 Universal Commands

The universal commands are in the code range 10 to 1F hex. (see Table 3-8). They are effective, without previous addressing, on all devices connected to the bus.

Table 3-6

Command	BASIC command with R&S controllers	Effect on SMY
<b>DCL</b> (Device Clear)	IECDCL	Aborts processing of commands just received and sets the command processing software to a defined initial status. Clears the output buffer The device setting is not changed.
<b>LLO</b> (Local Lockout)	IECLLO	The LOC key is inhibited.
<b>SPE</b> (Serial Poll Enable)	IECSPE <sup>1)</sup>	Ready for Serial Poll.
<b>SPD</b> (Serial Poll Disable)	IECSPD <sup>1)</sup>	End of Serial Poll.

1) The BASIC command "IECSPL addr, status" contains the commands "IECSPE" and "IECSPD", additionally reads the status of the device with address "addr" and stores it in the integer variable "status".

#### 3.4.2 Addressed Commands

The addressed commands are in the code range 00 to 0F hex. (Table 3-8). They only act on devices addressed as Listeners (by the BASIC command "IECLAD addr").

Table 3-7

Command	BASIC command with R&S controllers	Effect on SMY
<b>SDC</b> (Selected Device Clear)	IECSDC	Aborts processing of commands just received and sets the command processing software to a defined initial status. Clears the output buffer The device setting is not changed.
<b>GTL</b> (Go To Local)	IECGTL	Switchover to local status (manual operation).



Table 3-8 ASCII/ISO- and IEC character set

Control					Numbers Symbols				Upper case				Lower case				
0	NUL		16	DLE		32	SP	48	0	64	@	80	P	96	.	112	p
1	SOH	GTL	17	DC1	LLO	33	!	49	1	65	A	81	Q	97	a	113	q
2	STX		18	DC2		34	"		2	66	B	82	R	98	b	114	r
3	ETX		19	DC3		35	#	51	3	67	C	83	S	99	c	115	s
4	EOT	SDC	20	DC4	DCL	36	\$	52	4	68	D	84	T	100	d	116	t
5	ENQ	PPC	21	NAK	PPU	37	%	53	5	69	E	85	U	101	e	117	u
6	ACK		22	SYN		38	&	54	6	70	F	86	V	102	f	118	v
7	BEL		23	ETB		39	'	55	7	71	G	87	W	103	g	119	w
8	BS	GET	24	CAN	SPE	40	(	56	8	72	H	88	X	104	h	120	x
9	HT	TCT	25	EM	SPD	41	)	57	9	73	I	89	Y	105	i	121	y
10	LF		26	SUB		42	*	58	:	74	J	90	Z	106	j	122	z
11	VT		27	ESC		43	+	59	;	75	K	91	[	107	k	123	{
12	FF		28	FS		44	,	60	<	76	L	92	\	108	l	124	
13	CR		29	GS		45	-	61	=	77	M	93	]	109	m	125	}
14	SO		30	RS		46	.	62	>	78	N	94	^	110	n	126	~
15	SI		31	US		47	/	63	?	79	O	95	-	111	o	127	DEL
Addressed Commands			Universal Commands		Listener Addresses				Talker Addresses				Secondary addresses and commands				

Key for control:

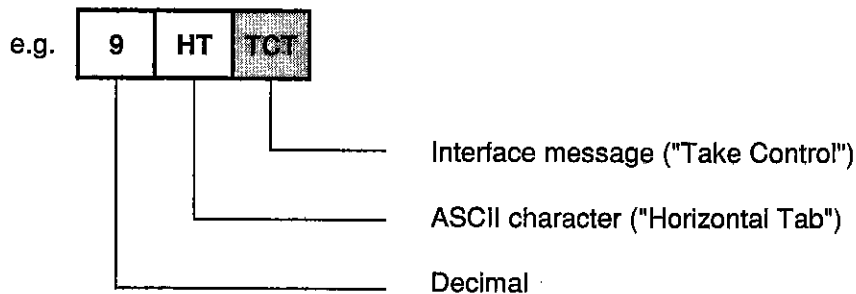

### 3.5 Service Request and Status Register

Fig. 3-3 shows the status registers and the links between them. In line with IEEE 488.2, the status byte (STB) and its associated mask register (SRE), which are also present with older instruments, have been supplemented by the event status register (ESR) and its mask register, event status enable (ESE).

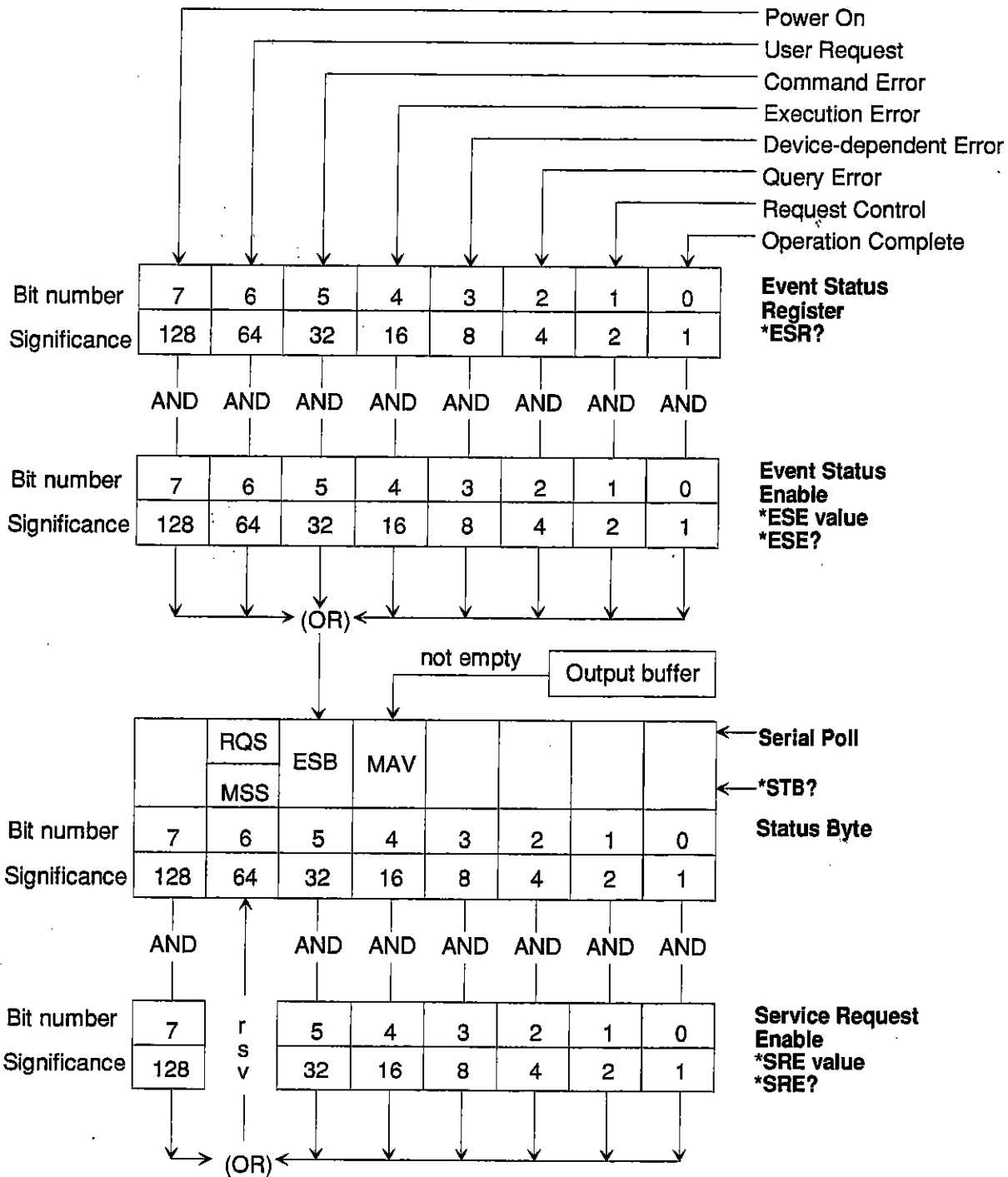

Fig. 3-3 Status registers

A bit is set to 1 in the **event status register (ESR)** with certain events (e. g. fault, ready message); see Table 3-9.

These bits remain set until cleared by one of the following conditions:

- \* by reading the event status register (by command \*ESR?)
- \* the command \*CLS
- \* the power supply is switched on (the Power On bit is set afterwards, however).

Table 3-9 Meaning of the event status register

Bit 7	<b>Power On</b> is set when the SMY is switched on or if the AC supply is restored after a failure.
Bit 6	<b>User Request</b> The operator can set this bit by activating special function 19 in the local status via the keyboard and thus initiate a Service Request with a corresponding setting of the mask registers. This function is useful if test sequences require manual operation as well as control via the IEC bus.
Bit 5	<b>Command Error</b> This is set if one of the following errors is detected during analysis of the received commands: <ul style="list-style-type: none"> <li>● Syntax error (error 50),</li> <li>● Illegal unit (error 52),</li> <li>● Illegal header (error 53),</li> <li>● A number has been combined with a header for which a subsequent numerical value is not envisaged (error 50, e. g. INCREMENT:RF 10 KHZ).</li> </ul> In addition, the corresponding error code is displayed and stored internally just as when entering via the keyboard.
Bit 4	<b>Execution Error</b> is set if one of the following errors has been detected during execution of the received commands <ul style="list-style-type: none"> <li>● A number is outside the permissible range (for the respective parameter) (error 51).</li> <li>● The command AF: OFF has been sent although AM or FM/PHM was still switched on (error 54).</li> <li>● A parameter is to be varied although it is not switched on (error 56).</li> <li>● The FM deviation or the RF cannot be set because the FM deviation is too large for the selected RF (error 55). Attention must be paid to the correct sequence if both the FM deviation and the RF are changed. This error may briefly occur if the sequence is incorrect and if the deviation values are large and acceptance of a parameter value is then prevented.</li> <li>● FM DC center frequency calibration was called without first switching on FM DC.</li> <li>● Overrange/underrange settings (error 70 to 72 and 75 to 77, see Table 2-3). The setting is nevertheless executed in these cases.</li> </ul>
Bit 3	<b>Device-dependent Error</b> is set <ul style="list-style-type: none"> <li>● if function errors occur (errors 1 to 15, see Table 2-3) or</li> <li>● if the external modulation signal is outside the tolerance range (Error 73 and 74).</li> </ul>
Bit 2	<b>Query Error</b> This bit is set: <ul style="list-style-type: none"> <li>● If the controller wishes to read data from the SMY but a data request (query message) has not been previously output.</li> <li>● If the data present in the output buffer of the SMY have not been read out and a new command line has been sent to the SMY instead. In this case the output buffer is cleared.</li> <li>● If the requested data exceed the capacity of the output buffer (approx. 200 characters).</li> </ul>
Bit 1	<b>Request Control</b> Not used in SMY.
Bit 0	<b>Operation Complete</b> This bit is set by the command ""OPC" if all previous commands have been processed and executed.

Using the **event status enable mask register (ESE)**, the user can select the bits in the event status register which also set the sum bit ESB (bit 5 in the status byte) through which a service request can be triggered. The sum bit is only set if at least one bit in the ESR and the corresponding bit in the ESE are set to 1. The sum bit is automatically cleared again if the above condition is no longer satisfied, e. g. if the bits in the ESR have been cleared by reading the ESR or if the ESE has been changed.

The event status enable mask register is written by the command "**\*ESE value**" ("value" is the contents in decimal) and can be read again using the command "**\*ESE?**". It is set to zero when the power supply is switched on if the Power On Clear flag is 1 (**\*PSC 1**).

It is not changed by other commands or interface messages (DCL, SDC).

Only the following bits are used in the **status byte (STB)**:

Bit No.	Bus Line	Designation	Meaning
4	DIO 5	MAV	Message Available Indicates that a message is present in the output buffer which can be read. The bit is 0 if the output buffer is empty.
5	DIO 6	ESB	Sum bit of the event status register
6	DIO 7	RQS MSS	Request Service (read by Serial Poll) Master Status Summary (read by *STB?)

It should be noted that the bits of the status registers are numbered 0 to 7 in accordance with IEEE 488.2, but the bus data lines are designated DIO 1 to DIO 8.

Using the **service request enable mask register (SRE)**, the user can determine whether the RQS bit of the status byte is also set when the MAV or ESB bit switches from 0 to 1 and if a Service Request is sent to the controller by activating the SRQ line. The following possibilities exist since each bit in the service request enable mask register is assigned to the corresponding bit in the status byte:

Contents of the SRE (decimal)	Bit no. set in the SRE	Effect
0	--	No Service Request
16	4	Service Request when the MAV bit is set (message in output buffer)
32	5	Service Request when the ESB bit is set (at least 1 bit set in the event status register and not masked)
48	4+5	Service Request in both of the above cases

The service request enable mask register (SRE) is written with the command "**\*SRE value**" ("value" is the contents in decimal) and can be read again using the command "**\*SRE?**". It is set to zero when the power supply is switched on if the Power On Clear flag is 1, and the Service Request function of the SMY is thus inhibited. The SRE mask register is not changed by other commands or interface messages (DCL, SDC).

Several devices can trigger a Service Request simultaneously, the open collector drivers cause an OR function on the SRQ line. The controller must read the status bytes of the devices to identify which device has triggered the Service Request. A set RQS bit (bit 6/DIO 7) indicates that the device is transmitting a Service Request.

The status byte of the SMY can be read in the following manner:

\* **By the command `"*STB?"`**

MSS (Master Status Summary) is transferred as bit 6. MSS is 1 if at least 1 bit in the status byte is set and the corresponding bit in the Service Request Enable mask register (SRE) is also set.

The contents of the status byte - including MSS bit - is output in decimal. It is, however, not possible to detect a set MAV bit in this manner. The status byte is not modified by reading and a possibly present Service Request is not cleared.

\* **By a Serial Poll**

(With R&S-BASIC: IEC SPL adr, status.)

The contents is transferred in binary form as *one* byte. RQS is sent as bit 6 (Request Service). RQS is set if the addressed device has caused the Service Request. The RQS bit is subsequently set to zero and the Service Request becomes inactive, the other bits of the status byte are not changed.

When MSS is cleared, RQS is also cleared, e. g. by setting the Service Request Enable mask register (SRE) to zero.

The status byte is cleared:

\* **By `*CLS` at the start of a command line**

At the start of a command line, the output buffer (and thus the MAV bit) is cleared. `*CLS` clears the event status register (and thus the ESB bit). This again clears the MSS or RQS bit and the Service Request message.

\* **By handling the entries in the status byte**

With the MAV bit set:	By reading the contents of the output buffer	(IECIN addr, AS)
With the ESB bit set:	By reading the event status register	(IECOUT addr, <code>"*ESR?"</code> )
		IECIN addr, ES)

This also clears the MSS or RQS bit in the status byte and the Service Request.

### Program example:

(Rohde & Schwarz BASIC has been used; the IEC bus address of the SMY has been taken to be 28).

In the program example, a service request is triggered on detection of an error, the type of error being determined from the event status register.

```
10 IECTERM 10 _____ Input terminator: new line
20 ON SRQ GOSUB 100
30 IECOUT28, "*CLS; *ESE 60; *SRE 32" _____ for Service Request in the event of error
.
.
.
100 REM-----
110 REM SERVICE REQUEST ROUTINE
120 REM-----
130 IECSP1 28, S%
140 IF (S% AND 64) = 0 THEN GOTO 300 _____ SRQ not from SMY
150 IECOUT28, "*ESR?"
160 IECIN 28, E$ _____ Read Event Status Register
170 E% =VAL(E$)
180 IF (E% AND 32) <>0 THEN PRINT "COMMAND ERROR"
190 IF (E% AND 16) <>0 THEN PRINT "EXECUTION ERROR")
200 IF (E% AND 8) <>0 THEN PRINT "DEVICE-DEPENDENT ERROR"
210 IF (E% AND 4) <>0 THEN PRINT "QUERY ERROR"
220 ON SRQ GOSUB 100
230 RETURN
240 REM-----
300 REM Service Request not from SMY
.
.
380 ON SRQ GOSUB 100
390 RETURN
```

### 3.6 Command Processing Sequence and Synchronization

The signal generator features a maximal transmission rate of 8300 characters/sec. for receiving data. The commands received are first stored temporarily in an input buffer which can accommodate a maximum of 81 to 121 characters. Once the terminator has been received, the commands are processed in the sequence in which they were sent. During this time, the IEC bus can be used for communication with other devices.

Command lines which exceed the capacity of the input buffer are processed in several parts. The bus is occupied during this time.

Commands **\*OPC** and **\*OPC?** (Operation Complete) are used as feedback information indicating the time when processing of the received commands is terminated and the output signal of the SMY has settled on the new values:

- **\*OPC** sets bit 0 in the event status register,
- **\*OPC?** provides message 1 in the output buffer which sets bit 4 (MAV) in the status byte,

if all preceding commands have been completed.

If the service request enable register (SRE) (and the ESE for command **\*OPC**) are appropriately set, both command **\*OPC** and command **\*OPC?** can trigger a service request.

Command **\*OPC?** permits a more simplified method of synchronization, see the program example outlined below!

These methods of synchronization are recommended if another device which requires the settled signal of the SMY is to be requested to start a measurement via the IEC bus.

Following **\*WAI**, the SMY does not process the new commands until all preceding commands have been completely executed and the output signal of the SMY has exactly settled. Thus, overlapping command execution, which may occur only in the following exceptional cases, can be avoided.

With the majority of the commands, no additional settling time is required for the output signal following command processing. The only exceptions are the switching of the mechanical attenuator initiated by commands **LEVEL**, **INCREMENT:LEVEL**, **DECREMENT:LEVEL**, **\*RST**, **PRESET**, **\*RCL**, **RECALL**, as well as the switching on of the amplitude modulation (AM) and the switching over of the reference frequency (**REFERENCE\_OSCILLATOR:INTERNAL/EXTERNAL**).

When commands **\*OPC**, **\*OPC?** or **\*WAI** are used, this additional settling time then required is automatically taken into consideration.

### Program example:

The program example shows an easy method of synchronization. The command \*OPC? generates a message as soon as the preceding commands have been executed and the output signal of the SMY has settled. Since this message is to be read in line 30, the bus handshake is halted until the message is available. (Rohde & Schwarz BASIC; address of the SMY: 28)

```
10 IECTERM 10          input terminator: new line
20 IECOUT 28, "RF 123 MHZ; LEV 11.5DBM; *OPC?"
30 IECIN 28, A$        A$ is not used further
40 REM The SMY has executed the
45 REM commands in line 20.
50 REM Its output signal can, e.g.,
55 REM be used for measurements.
```

## 3.7 Error Handling

Any errors detected by the SMY in connection with operation via the IEC bus are indicated by setting a bit (bit 2, 4 or 5) in the event status register (see Table 3-9). Functional errors are signalled correspondingly by setting bit 3. These bits remain set until the ESR is read or cleared by the command \*CLS. This is in line with the IEEE 488.2 standard and enables triggering of a service request and program-controlled evaluation of the type of error (see program example as outlined at the end of section 3.5).

More detailed information is contained in the error codes which, just like with manual operation, are read out in the right-hand display. The display is overwritten by the next command and is therefore not always visible with IEC bus operation. It is therefore possible to have these error codes read out via the IEC bus using command 'ERRORS?'. If several errors are detected, the error codes are separated by commas. Code '0' indicates that no errors are currently detected. Input errors (codes 50 to 57) are cleared if a new command line is sent to the SMY. All other errors are indicated as long as the cause for error has not been removed.



### 3.8 Resetting Device Functions

The following table comprises the various commands and events which reset individual device functions.

Effect	Event					
	Switching on the operating voltage		DCL, SDC (Device Clear, Selected Device Clear)	Commands		
	Power On Clear Flag			*CLS	*RST	PRESET
	0	1				
Basic instrument setting (s. Section "Preset")	--	--	--	--	yes	yes
Set event status register ESR to zero	yes	yes	--	yes	--	--
Set mask registers ESE and SRE to zero	--	yes	--	--	--	--
Clear output buffer	yes	yes	yes	2)	--	--
Clear Service Request	yes	1)	--	2)	--	--
Message from SMY: setting "HEADER:ON", talker terminator new line + end	yes	yes	--	--	yes	--
Reset command processing and input buffer	yes	yes	yes	--	--	--

1) Yes, but "Service Request on Power On" is possible.

2) Yes if the command is at the beginning of a command line.

### 3.9 Local/Remote Switchover

The device is in the local mode (manual operation) when switched on.

If the SMY is addressed by a controller as a listener (by means of R & S BASIC commands IECOUT or IECLAD), it enters the remote status (remote control) in line with the standard and remains in this mode even after data transfer has been completed. This is indicated by the REMOTE-LED. Except for the LOC/IEC ADD key, all control elements of the front panel are disabled.

There are two possibilities to return to local:

- \* By the addressed command GTL (Go to Local) from the controller.
- \* By pressing the LOC/IEC ADD key. Data output from the controller to the SMY should be stopped before pressing the LOC/IEC ADD key or the SMY will immediately enter the remote status again. The function of the LOC/IEC ADD key can be inhibited from the controller by sending the universal command LLO (Local Lockout).

The remaining device settings are not modified by a change in status from "remote" to "local" or vice versa.

### 3.10 Interface Function

According to the IEC 625-1 standard, devices with remote control via the IEC bus can be equipped with different interface functions. The table lists the interface functions which apply to the SMY.

Abbreviation according to IEC 625-1	Interface functions
SH1	Source Handshake complete ability
AH1	Acceptor Handshake complete ability
L4	Listener function, complete ability, unaddressing if MTA
T6	Talker function, complete ability, ability to reply to serial poll, unaddressing if MLA
SR1	Service Request complete ability
PPO	Parallel Poll function, not available
RL1	Remote/local switchover function complete ability
DC1	Device Clear complete ability
DT0	Device Trigger not available
C0	Controller function, not available

### 3.11 IEC-Bus Connector and Bus Lines

The IEC bus connector is positioned at the rear panel of the instrument. The SMY is equipped with a 24-contact socket in compliance with the IEEE 488 standard.

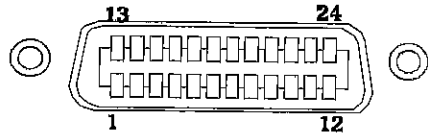

Connector	Signal	Connector	Signal
1	Data I/O 1	13	Data I/O 5
2	Data I/O 2	14	Data I/O 6
3	Data I/O 3	15	Data I/O 7
4	Data I/O 4	16	Data I/O 8
5	EOI	17	REN
6	DAV	18	Ground (for DAV)
7	NRFD	19	Ground (for NRFD)
8	NDAC	20	Ground (for NDAC)
9	IFC	21	Ground (for IFC)
10	SRQ	22	Ground (for SRQ)
11	ATN	23	Ground (for ATN)
12	Shield	24	Logic ground

Fig. 3-4 Pin assignment

The standardized interface contains three groups of bus lines

1) **Data bus** with 8 lines DIO 1 to DIO8.

Data transmission is bit-parallel and byte-serial and the characters can be transmitted in ISO 7-bit code (ASCII code).

DIO 1 represents the least significant bit and DIO 8 the most significant bit.

2) **Control bus** with 5 lines.

This is used to transmit control functions:

**ATN** (Attention)

becomes active Low during transmission of addresses, universal commands or addressed commands to the connected devices.

**REN** (Remote Enable)

enables device to be switched to remote control.

**SRQ** (Service Request)

enables a connected device to send a Service Request to the controller by activating this line.

**IFC** (Interface Clear)

is activated by the controller in order to set the IEC interfaces of the connected devices to a defined initial status.

**EOI** (end or Identify)

can be used to identify the end of data transmission and is used with a parallel poll.

3) **Handshake bus** with 3 lines.

This is used to control the data transmission sequence.

**NRFD** (Not Ready For Data)

an active Low on this line signals to the talker/controller that one of the connected devices is not ready to accept data.

**DAV** (Data Valid)

is activated by the talker/controller shortly after a new data byte has been applied to the data bus.

**NDAC** (Not Data Accepted)

is held at active Low by the connected device until the device has accepted the data present on the data bus.

More detailed information, such as the data transmission timing, can be obtained from the IEC 625-1 standard.

## 4 Maintenance and Troubleshooting

### 4.1 Maintenance

Under normal operating conditions, regular maintenance is not required. How to replace the lithium battery is described in the service manual.

#### 4.1.1 Cleaning the Exterior of the Instrument

To clean the exterior of the instrument, use a soft, non-fraying dust cloth.

**Attention!** *Never use solvents such as thinner, acetone or other similar substances, as they may damage the lettering on the front panel and/or plastic components.*

#### 4.1.2 Storage

The storage temperature range of the instrument is -40 to +70 °C. If the instrument is to be stored for any length of time, protect it from dust.

### 4.2 Function Check (Self-test)

#### 4.2.1 Self-test

The instrument performs a self-test after being switched on and while it is in operation. The contents of ROM are checked during the power-up process. The RAM contents are checked when memory is accessed. The most important instrument functions are automatically monitored during operation.

If an error is detected, the status LED will flash. After the status key has been pressed, the status code is shown in the modulation display and the indicator "Err." is shown in the amplitude display:

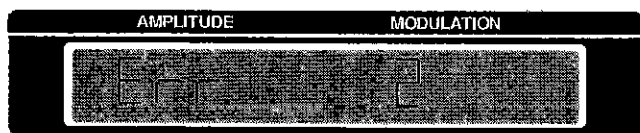

The status codes of errors are listed in chapter 2.23, table 2-3.

If necessary, the individual diagnostic test points can be directly accessed (see the service manual).

#### 4.2.2 Calibration

By drastic changes in operating temperature, or after replacing a module or the lithium battery, it is necessary to call the internal calibration routines. To do this, use the special functions (see chapter 2.21). Only the level correction calibration requires an external measuring instrument.

## 5 Testing the Rated Specifications

### 5.1 Required Measuring Equipment and Accessories

Table 5-1

Item	Instrument	Required specifications	R&S order no.	Use described in section
1	Frequency counter	Range 10 Hz to 1040 MHz (2080 MHz for SMY02) Resolution 1 Hz	included in item 2	5.2.2 5.2.3 5.2.14
2	RF analyzer	Range 0.1 to 1040 MHz (2080 MHz for SMY02) Crystal stabilized, dynamic range 90 dB	FSB 848.0020.52	5.2.4 5.2.6 5.2.8 5.2.10 5.2.12 5.2.19 5.2.32 5.2.38
3	Power meter	Range 0.1 to 1040 MHz (2080 MHz for SMY02) Power up to 100 mW, Z = 50 $\Omega$ , error < 0.1 dB resolution < 0.02 dB	NRVS 1020.1809.02 NRVS-Z51 857.9004.02	5.2.5 5.2.7
4	Precision attenuation set	Range > 500 MHz Attenuation 0 to 120 dB Z = 50 $\Omega$	DPSP 334.6010.02	5.2.6
5	Controller	IEC 625-1 interface	PSA15 1012.1003.03	5.2.4
6	Test generator	Range up to 1040 MHz (2080 MHz for SMY02) Low noise	SMHU 835.8011.58	5.2.8 5.2.11
7	SWR bridge	Range up to 1040 MHz (2080 MHz for SMY02) Z = 50 $\Omega$	ZRB2 373.9017.53	5.2.8
8	RF analyzer	Range up to 2.8 GHz Dynamic range > 40 dB	FSB 848.0020.52	5.2.9
9	Mixer	Range up to 1040 MHz (2080 MHz for SMY02) Ring modulator, standard level		5.2.11
10	Lowpass filter 200 kHz	Z = 50 $\Omega$ for f > 200 kHz		5.2.11
11	Instrument amplifier	Range 1 to 20 kHz Gain 20 dB, inherent noise < 5 nV/1 Hz test bandwidth		5.2.11
12	AF analyzer	Range up to 20 kHz Sensitivity < 3 $\mu$ V R <sub>in</sub> > 10 k $\Omega$	UPD 1030.7500.02	5.2.11
13	Oscilloscope	DC to 100 MHz, 0.1 V/div		5.2.11 5.2.32 5.2.33
14	Adjustable lowpass filter	Half octave intervals 30 to 1360 MHz		5.2.12
15	Deviation meter	Range up to 2080 MHz Residual FM at 250 MHz < 1 Hz (CCITT) < 2 Hz (30 Hz to 20 kHz)	FMB 856.5005.52	5.2.13

Item	Instrument	Required specifications	R&S order no.	Use described in section
16	Modulation analyzer	Frequency range up to 1040 MHz (2080 MHz for SMY02) AM, FM, $\phi$ M, error < 1%	FAM 334.2015.54 FAM-B2 334.4918.02 FAM-B8 334.5714.02 FMB (for SMY 02)	5.2.13 5.2.16 5.2.17 5.2.18 5.2.21 to 5.2.24
17	AF generator	Frequency range up to 100 kHz Frequency response < 0.01 dB	AFG 377.2100.02	5.2.15 5.2.18 5.2.24
18	AF voltmeter	Frequency range up to 100 kHz Frequency response < 0.01 dB	URE3 350.5315.03	5.2.14 5.2.15 5.2.20 5.2.25
19	Distortion meter	Frequency range up to 100 kHz Resolution < 0.05%	included in item 16	5.2.14 5.2.17
20	Power signal generator	Level 30 dBm up to 1040 MHz (2080 MHz for SMY02)	SMGL 1020.2005.52	5.2.30 5.2.31
21	RF peak-value rectifier	Frequency range 0.1 to 1040 MHz (2080 MHz for SMY02) 50 $\Omega$ , frequency response < 1 dB		5.2.20 5.2.25

## 5.2 Test Procedure

### 5.2.1 Display and Keyboard

The special function "Display Test" (called up via SPECIAL 31) carries out a test of the displays. All displays are lit up.

The keys are tested by pressing them and their function checked against the display.

### 5.2.2 Frequency Setting

SMY setting: Unmodulated, level 0 dBm

Test setup: Synchronize reference frequency from SMY and from frequency counter.

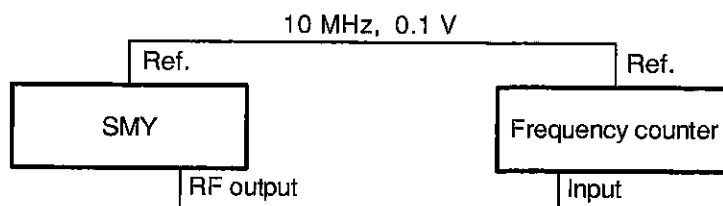

Test: Set the following frequencies on the SMY and check using the frequency counter.

10 MHz	150 MHz	2000 MHz (for SMY02)
60 MHz	450 MHz	
90 MHz	1000 MHz	

The values on the counter must not deviate by more than  $\pm 1$  Hz.

### 5.2.3 Reference Frequency

- Allow at least one hour for the instrument to warm up.
- Connect a calibrated frequency counter to output REF FREQ 10MHz (rear panel).

The relative frequency error must not exceed (after 30 days of operation)

$1 \cdot 10^{-6}/\text{year} + 2 \cdot 10^{-6}$  with the standard design  
 $1 \cdot 10^{-9}/\text{day} + 5 \cdot 10^{-8}$  with the option SMY-B1 Reference Oscillator, OCXO

in the rated temperature range.

### 5.2.4 Settling Time

A crystal stabilized RF analyzer with a storage CRT which can be externally triggered by positive TTL edges is required to measure the settling time. The transient is made visible by edge demodulation with a 0-Hz span. Using a controller, two frequencies are set alternately on the SMY via the IEC bus. The controller should only activate the EOI line with the last data byte and must not otherwise send a terminator. The analyzer is adjusted such that one of the two frequencies lies on a filter edge. If the analyzer is triggered by the positive edge of the EOI signal, the transient appears on the CRT following the last character of the IEC-bus transmission.

Test setup:

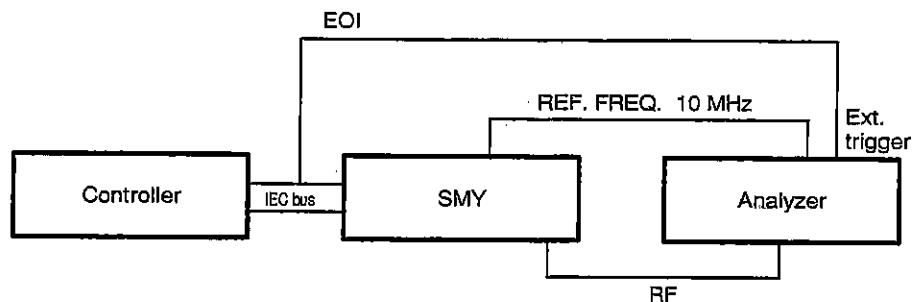

Test: Synchronize reference frequency from the SMY and the RF analyzer. Connect the IEC bus and the RF line. Connect the EOI line (pin 5 on the IEC-bus connector) to the external trigger input of the analyzer. Set the SMY to 0 dBm and to the end value of the frequency jump to be measured. Set the reference level to -5 dBm on the analyzer, the amplitude scale to 1 dB/div, the resolution bandwidths to 1 kHz and the span to 3 kHz. Increase the centre frequency until the filter edge passes through the centre point of the CRT. The span can now be reduced to 0 Hz and the scale calibrated on the CRT using frequency steps of 100 Hz. The transient response appears on the CRT if the test program is now started and the analyzer switched to external triggering. The settling time (period up to final frequency  $1 \cdot 10^{-7}$ ) must be  $< 60$  ms.



Test program:            Settling time

```
10 IECTERM 1
20 IECDCCL : HOLD 500
30 IECOUT27, "LEV 0DBM"
40 INPUT "STARTFREQUENZ IN MHZ"; F1$
50 INPUT "STOPPFREQUENZ IN MHZ"; F2$
60 IECOUT27, "RF" + F1$ + "MHZ"
70 HOLD 200
80 IECOUT27, "RF" + F2$ + "MHZ"
90 INPUT "WIEDERHOLUNG"; W$
100 IF W$ = "J" THEN 60
110 GOTO 40
```

### 5.2.5 Output Level

SMY setting:            Unmodulated, level 0 dBm,  
                          frequencies 9 kHz to 1040 MHz (2080 MHz for SMY02)

Test setup:            Connect power meter to RF output.

Test:                    The frequency response must not exceed 1 dB.

### 5.2.6 Attenuation Set

SMY setting:            Unmodulated, 100 MHz, 13 dBm (19 dBm with option SMY-B40)

Setting of precision  
attenuation set:        120 dB attenuation

Test receiver setting: 100 MHz, -10 dB $\mu$ V, linear, mean value,  
                          bandwidth 7.5 kHz

Test setup:

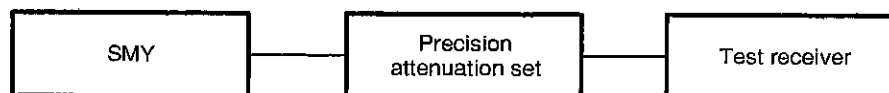

Ensure that the cable connections are RF tight.

**Test:** The nominal attenuation values according to the performance test report must be taken into account.

- Note the level displayed on the test receiver as the reference value (approx. 0 dB $\mu$ V).
- Repeat the measurement with the settings shown in Table 5-2.
- The difference from the reference value must not exceed 1 dB.

Table 5-2

SMY level in dBm without option SME-B40	SMY level in dBm with option SME-B40	Attenuation of the precision attenuation set dB
13	19	120
8	14	115
3	09	110
-7	-1	100
-27	-21	80
-47	-41	60
-67	-61	40
-87	-81	20
-107	-101	0

### 5.2.7 Non-interrupting Level Setting

**SMY setting:** Unmodulated, 100 MHz, 13 dBm (19 dBm with option SMY-B40)  
Level VAR STEP 5 dB,  
special function "Non-interrupting level setting"

**Test setup:** Connect power meter to RF output.

**Test:** Calibrate the power meter to 0 dB (for relative level measurements) or note the absolute level. Reduce the level on the SMY in 2-dB steps using the STEP key and check the level jumps on the power meter.

Permissible deviation:

Reduction	5 dB	10 dB	15 dB	20 dB
Tolerance	± 0.2 dB	± 0.4 dB	± 0.6 dB	± 0.8 dB

### 5.2.8 Output Reflection Coefficient

**SMY setting:** Frequency 5 to 1040 MHz (2080 MHz for SMY02), unmodulated,  
level 0 dBm

**RF generator setting:** Frequency  $f_{SMY}$  - 100 Hz, unmodulated,  
level -140 dBm

RF analyzer  
setting:

Center frequency	$f_{SMY}$
RES BW = Video BW	10 kHz
Span	0 Hz
Sweep Time	30 ms
Scale	linear

Test setup:

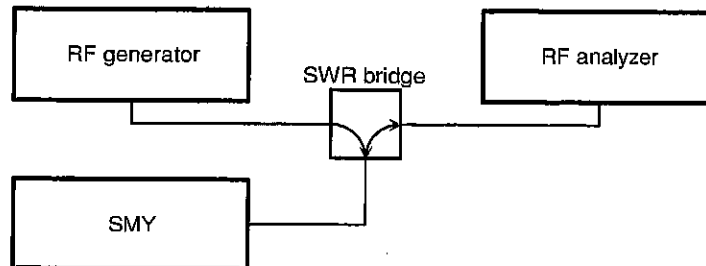

Test:

- At the spectrum analyzer, now bring the line indicated approx. into the center of the screen by varying the reference level and read and note down the level as a reference level.
- Screw off the bridge from the SMY and increase the level at the second signal generator until the reference level is measured again at the analyzer.
- Screw the bridge or the directional coupler onto the SMY again.
- A more or less wavy line representing the VSWR of the SMY is to be seen now at the spectrum analyzer. The VSWR is to be calculated from the maximal and the minimal voltage according to

$$VSWR = \frac{V_{max}}{V_{min}}$$

The ripple must not exceed 1.5. An upper limit value of 1.8 is valid with frequencies > 1040 MHz.

## 5.2.9 Harmonics

SMY setting: Unmodulated, level 10 dBm (16 dBm with OPTION SMY-B40), frequency 9 kHz to 1040 MHz (2080 MHz for SMY02)

Test setup: Connect RF analyzer to the RF output of the SMY.

Test: Sweep through the output frequency of 9 kHz to 1040 MHz (2080 MHz for SMY02) and check the harmonics on the RF analyzer.

– Without option SMY-B40, the harmonic level must not exceed –30 dBc.

– With option SMY-B40, the harmonic level must not exceed –25 dBc.

Ensure that the RF analyzer is not overloaded.

### 5.2.10 Spurious

SMY setting: Unmodulated, level 0.1 dBm,  
frequency 100 kHz to 1000 MHz

Test setup: Connect RF analyzer to the RF output.

Test: The spurious suppression is preferably tested at the following frequencies:

Table 5-3

SMY frequency	Search frequency	Spurious suppression
64.999999 MHz	640 MHz 705 MHz 75 MHz	< -70 dBc
544.08 MHz 640.005 MHz 992.03 MHz 1024.02 MHz	544.03 MHz 640 MHz 992.058 MHz 1024.07 MHz	< -70 dBc

### 5.2.11 SSB Phase Noise

In order to measure the SSB phase noise, the output signal of the SMY is down-converted with a signal of the same frequency from a reference signal generator. The carrier is then rejected and the noise spectrum converted to a low frequency. This low-frequency noise spectrum can be measured using an AF spectrum analyzer.

SMY setting: Unmodulated, level 0 dBm,  
frequency 64 / 100 / 779 / 1040 MHz (and 2080 MHz for SMY02)

Reference generator: Unmodulated, level 7 dBm,  
frequency analog to SMY setting

Oscilloscope: DC, 0.1 V/div, triggering AUTO

AF analyzer: Bandwidth 1 kHz, 5 kHz/div

Test setup:

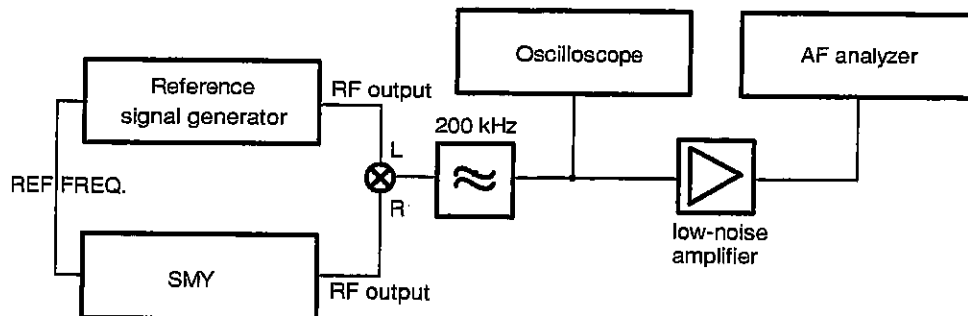

Synchronize the reference frequencies from the SMY and the reference signal generator.

Test:

- Set SMY to 65.02 MHz. Read the reference value on the AF analyzer at 20 kHz.
- Set SMY to 65 MHz. Set a beat of 1 Hz using a step of 1 Hz upwards or downwards from the reference generator setting and stop the beat with a single step at the zero point on the oscilloscope ( $\pm 50$  mV). This sets the two input signals of the mixer in the phase quadrature.
- Read the noise level on the analyzer at 20 kHz and convert to a 1-Hz bandwidth (if e.g. a bandwidth of 1 kHz is used for the measurement, 30 dB must be subtracted from the measured noise level). Take into account the form factor in the case of analyzers with mean-value rectification.
- The SSB phase noise is calculated as follows:

	Example
Measured noise level (1-Hz bandwidth)	-118 dBm
Minus reference level	-(+12 dBm)
Minus 6 dB because 2 side bands are measured	-6 dB
	-136 dBc

- Repeat the measurement at 100 MHz, 779 MHz, 1040 MHz (and 2080 MHz for SMY02).

The following values of SSB phase noise must not be exceeded:

Table 5-4

Carrier frequency	SSB phase noise at 20 kHz from carrier
64 MHz	-114 dBc
100 MHz	-132 dBc
779 MHz	-114 dBc
1040 MHz	-114 dBc
2080 MHz for SMY02	-108 dBc

SMY43 only:

Carrier frequency	Carrier offset	SSB phase noise
894 MHz	45 kHz	< -126 dBc
894 MHz	300 kHz	< -138 dBc
1990 MHz	600 kHz	< -138 dBc

Note: This measurement takes into consideration the SSB phase noise of both generators. The reference signal generator must therefore be at least 10 dB better than the SMY in order to achieve an exact measurement.

## 5.2.12 Broadband Noise

The carrier of the SMY is attenuated using a filter in order to measure the broadband noise using an RF analyzer.

SMY setting: Unmodulated, level 5.1 dBm without option B40, 11.1 dBm with option B40  
frequency 100 kHz to 1000 MHz

Test setup:

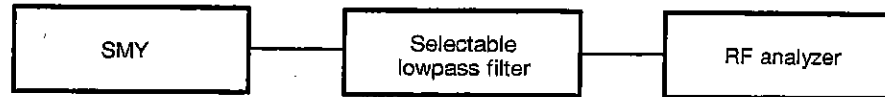

- Test:
- Set the lowpass filter such that the SMY carrier is attenuated by at least 20 dB.
  - Set the analyzer as sensitive as possible (no pre-attenuation). Measure the noise level in the passband of the filter and convert to a 1-Hz bandwidth. This level, referred to 0.1 dBm, is the broadband noise level.

The broadband noise level must not exceed -140 dBc.

## 5.2.13 Residual FM

SMY setting: Unmodulated, level 0 dBm,  
frequency 520.000001 to 1040 MHz (2080 MHz for SMY02)

Test setup:

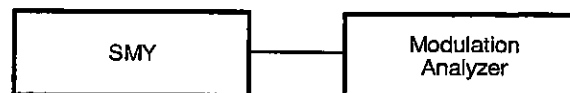

Test: Measure the residual FM with a CCITT weighting filter or unweighted (30 Hz to 20 kHz) and an RMS rectifier.

In the given frequency range, the residual FM must not exceed 10 Hz with CCITT weighting filter or 20 Hz unweighted.

Possible test frequencies: 600, 800 and 1000 MHz.

The inherent residual FM of the modulation analyzer must be taken into account by calibration.

### 5.2.14 Modulation Generator

SMY setting: AF 10 Hz to 500 kHz

Test setup:

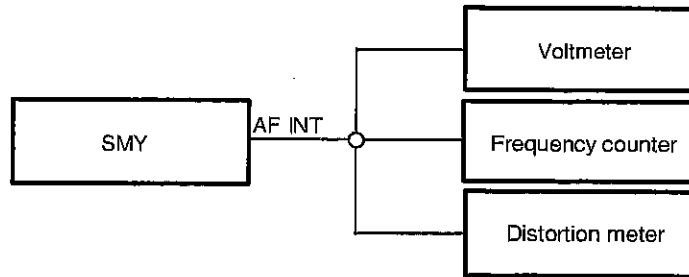

Test: Vary the frequency of the modulation generator from 10 Hz to 500 kHz and measure the level, frequency and distortion.

The level at 1 kHz must be  $1\text{ V} \pm 1\%$ .

Frequency response: < 0.2 dB up to 50 kHz  
< 0.3 dB up to 100 kHz

The frequency error must not exceed  $5 \cdot 10^{-5}$ .

The distortion at 1 kHz must not exceed 0.1%.

### 5.2.15 Function Test of the External Modulation Level Monitoring

SMY setting: Level 0 dBm, a) FM EXT 50 kHz  
b) AM EXT 80%

Test setup: Apply a modulation signal of 1 kHz to the modulation input "FM/φM EXT" (test a) or "AM EXT" (test b).

Test: EXT LOW must light up in the modulation display with an input level of 0.97 V.

EXT HIGH must light up in the modulation display with an input level of 1.03 V.

Neither EXT LOW nor EXT HIGH is to light up with an input level of 0.99 to 1.01 V.

### 5.2.16 AM Modulation Depth

SMY setting: Level 0.1 dBm, frequency 0.1 to 1040 MHz (2080 MHz for SMY02)  
AM INT 0.5 to 80%, AF 1 kHz

Test setup: Connect modulation analyzer to RF output.

Test: Without option SMY-B40, the deviation of the modulation depth from a set value must not exceed 4% of the display +1% (absolute).  
With option SMY-B40, the deviation of the modulation depth from a set value must not exceed 4% of the display +3% (absolute).

### 5.2.17 AM Distortion

SMY setting: Level 0.1 dBm, frequency 0.1 to 1040 MHz (2080 MHz for SMY02)  
AM INT 30% (80%), AF 1 kHz

Test setup: Connect modulation analyzer with distortion meter to RF output.

Test: without option SMY-B40:  
The distortion must not exceed 1% with 30% AM.  
The distortion must not exceed 2% with 80% AM.  
with option SMY-B40:  
for frequencies  $f < 10$  MHz, the distortion must not exceed 3 % (5 %)  
with 30 % (80 %) AM  
for frequencies  $f > 10$  MHz, the distortion must not exceed 1 % (2 %)  
with 30 % (80 %) AM

### 5.2.18 AM Frequency Response

SMY setting: Level 0 dBm, frequency 0.1 to 1040 MHz (2080 MHz for SMY02),  
AM EXT 60%

Test setup:

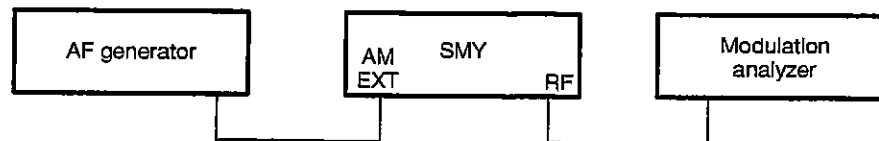

Test: Set a level of 1 V on the AF generator and vary the frequency from 10 Hz to 50 kHz.

The modulation frequency response up to 10 kHz must not exceed 0.4 dB.

The modulation frequency response up to 50 kHz must not exceed 3 dB.

### 5.2.19 AM DC

SMY setting: Level 0 dBm, frequency 1000 MHz, AM EXT 100%

Test setup: Connect RF analyzer to RF output of SMY.

Test: A DC voltage of +1 V applied to the AM modulation input must increase the RF level by 5.5 to 6.5 dB.

A voltage of -1 V must result in an attenuation of at least 30 dB.

### 5.2.20 Residual AM

SMY setting: Unmodulated, level 13 dBm,  
frequency 0.1 to 1040 MHz (2080 MHz for SMY02)

Test setup: Connect RF peak-value rectifier to SMY output. Connect RMS voltmeter with 20-kHz lowpass filter connected before to the output of the rectifier.

Test: The RMS value of the measured voltage must not exceed 200  $\mu$ V.



### 5.2.21 Incidental $\phi_M$ at AM

SMY setting: Level 0 dBm, frequency 4 to 1040 MHz (2080 MHz for SMY02),  
AM INT 30%, AF 1 kHz

Test setup: Connect modulation analyzer to RF output.

Test: Measure the phase modulation produced at various carrier frequencies.  
Permissible incidental  $\phi_M$ : < 0.2 rad at  $f < 1040$  MHz,  
< 0.4 rad at  $f > 1040$  MHz

### 5.2.22 FM Deviation Setting

SMY setting: Call special function 41 and special function 43,  
level 0 dBm, frequency 100 MHz,  
FM INT 1 to 100 kHz, AF 1 kHz

Test setup: Connect modulation analyzer to RF output.

Test: Measure the FM deviation at the following deviation settings:  
1 kHz, 10 kHz, 100 kHz, 1 MHz, 10 MHz  
The deviation from the set value must not exceed 3%.

### 5.2.23 FM Distortion

SMY setting: Level 0 dBm, frequency 100 MHz,  
FM INT 50 kHz, AF 1 kHz

Test setup: Connect modulation analyzer with distortion meter to the RF output of the SMY.

Test: The FM distortion must not exceed 0.3%.

### 5.2.24 FM Frequency Response

SMY setting: Level 0 dBm, frequency 100 MHz,  
FM EXT 100 kHz

Test setup: Connect AF generator to modulation input FM/ $\phi_M$  EXT. Connect calibrated  
modulation analyzer to RF output.

Test: Set a level of 1 V on the AF generator and vary the frequency from 10 Hz to  
2 MHz. The modulation frequency response must not exceed 3 dB.

### 5.2.25 Incidental AM at FM

- SMY setting: Level 0 dBm, frequency 0.1 to 1040 MHz (2080 MHz for SMY02)  
FM INT 40 kHz, AF 1 kHz
- Test setup: Connect RF peak-value rectifier to SMY output. Connect RMS voltmeter with 20-kHz lowpass filter connected before to the output of the rectifier.
- Test: The RMS value of the measured voltage must not exceed 224  $\mu$ V.

### 5.2.26 Stereo Modulation

- SMY setting: Call special function 41 and special function 43,  
level 0 dBm, frequency 93 and 108 MHz,  
FM external DC, FM deviation 40 kHz
- Test setup: Connect stereo coder to the FM/ $\phi$ M connector.  
Pilot tone 6.75 kHz, AF = 1 kHz.  
Connect FMB to RF output.
- Test: The cross-talk attenuation must not fall below 50 dB. The signal-to-noise ratio must be better than 70 dB, the unweighted signal-to-noise ratio better than 76 dB.  
The distortion must not exceed 0.3%.

### 5.2.27 PM Deviation Setting

- SMY setting: Call special function 41 and special function 43,  
level 0 dBm, frequency 100 MHz,  
PM INT 10.0 rad, AF 1 kHz
- Test setup: Connect spectrum analyzer to RF output.  
FM demodulator (the FM demodulator is used due to the higher FM accuracy of the FMB).
- Test: The FM deviation must be 10 kHz at the chosen setting. A phase deviation error of 5% corresponds to a deviation of 500 Hz from the nominal value.

### 5.2.28 PM Distortion

- SMY setting: Level 0 dBm, frequency 100 MHz,  
PM INT 12.5 rad, AF 1 kHz
- Test setup: Connect modulation analyzer to RF output.
- Test: The distortion must not exceed 0.5%.

### 5.2.29 PM Frequency Response

- SMY setting: Level 0 dBm, frequency 100 MHz,  
PM INT 12.5 rad, AF 20 Hz to 20 kHz
- Test setup: Connect modulation analyzer to RF output.
- Test: The modulation frequency response up to 20 kHz must be less than 3 dB.

### 5.2.30 Overvoltage Protection with OPTION SMY-B40

- SMY setting: Unmodulated, level -117 dBm, frequency 100 MHz
- Test setup 1: Connect a regulated power supply unit to the RF output of the SMY.
- Test: Apply a DC voltage to the RF output. The overvoltage protection must trip at a voltage of  $\pm$  (7.5 V to 8.5 V).
- Test setup 2: Connect a power signal generator with an RF power output of 0.5 to 2 W to the RF output of the SMY.
- Test: Apply a frequency of 25 to 1040 MHz (2080 MHz for SMY02) to the RF output. The overvoltage protection must trip at an RF power of 1 W to 2 W.

### 5.2.31 Overvoltage Protection without OPTION SMY-B40

- SMY setting: Unmodulated, level -117 dBm, frequency 100 MHz
- Test setup 1: Connect a regulated power supply unit to the RF output of the SMY.
- Test: Apply a DC voltage to the RF output. The overvoltage protection must trip at a voltage of  $6 \pm 1$  V.
- Test setup 2: Connect a power signal generator with an RF power output of 0.3 to 1.5 W to the RF output of the SMY.
- Test: Apply a frequency of 25 to 1040 MHz (2080 MHz for SMY02) to the RF output. The overvoltage protection must trip at an RF power of 0.5 to 1.1 W for SMY01 and 0.3 to 0.7 W for SMY02.

### 5.2.32 Pulse Modulation with OPTION SMY-B40

- SMY setting: Unmodulated, level 19 dBm
- Test setup 1: To determine the ON/OFF ratio, connect spectrum analyzer to the RF-output socket of the SMY and a pulse generator to the PULSE socket on the rear panel of the SMY.
- Test: Measure the output level of the SMY at various carrier frequencies for applied "High" and "Low" signal.  
The ON/OFF-ratio must be >70 dB at 70 MHz, linearly decreasing to > 65 dB at 520 MHz, > 65 dB up to 800 MHz, linearly decreasing to > 35 dB at 2080 MHz.
- Test setup 2: Use a two-channel oscilloscope to display the input signal from the pulse generator and the (mixed) output signal simultaneously. Trigger by the input signal. Set a rectangular pulse sequence with a frequency of about 1 MHz by means of the TTL-level. For carrier frequencies > 50 MHz, use mixer and set IF of about 50 MHz by means of an auxiliary signal generator. Evaluate the envelope of the keyed RF-signal on the oscilloscope.
- Test: The rise time (10%/90%) must be < 20 ns.  
The fall time (90%/10%) must be < 20 ns.  
The pulse delay time (50%-input pulse/50%-envelope) must be < 200 ns.

### 5.2.33 Pulse Modulation without OPTION SMY-B40

- SMY setting: Unmodulated, level 13 dBm
- Test setup 1: To determine the ON/OFF ratio, connect spectrum analyzer to the RF-output socket of the SMY and a pulse generator to the PULSE socket on the rear panel of the SMY.
- Test: Measure the output level of the SMY at various carrier frequencies for applied "High" and "Low" signal.  
The ON/OFF-ratio must be >80 dB.
- Test setup 2: Use a two-channel oscilloscope to display the input signal from the pulse generator and the (mixed) output signal simultaneously. Trigger by the input signal. Set a rectangular pulse sequence with a frequency of about 1 MHz by means of the TTL-level. For carrier frequencies > 50 MHz, use mixer and set IF of about 50 MHz by means of an auxiliary signal generator. Evaluate the envelope of the keyed RF-signal on the oscilloscope.
- Test: The rise time (10%/90%) must be typically 4  $\mu$ s.  
The fall time (90%/10%) must be typically 4  $\mu$ s.  
The pulse delay time (50%-input pulse/50%-envelope) must be typically 3.5  $\mu$ s.

## 5.3 Performance Test Report

ROHDE & SCHWARZ  
 SIGNAL GENERATOR SMY 01/02  
 Order No. 1062.5502.11/12  
 SER. ....

Date: .....  
 Name: .....

Item	Characteristic	Measure as in section	Min	Actual	Max	Unit
1	Function of keypads and displays	5.2.1	--		--	
2	Frequency setting	5.2.2	--		--	
3	Settling time	5.2.4	--		60	ms
4	Output level test level 0 dBm frequency response	5.2.5	--		1	dB
5	Attenuation set error	5.2.6	--		1	dB
6	Non-interrupting level variation Error at -5 dB -10 dB -15 dB -20 dB	5.2.7	-- -- -- --		$\pm 0.2$ $\pm 0.4$ $\pm 0.6$ $\pm 0.8$	dB dB dB dB
7	Output reflection coefficient VSWR at $\leq 1040$ MHz $> 1040$ MHz	5.2.8	-- --		1.5 1.8	
8	Harmonics at 10 dBm with OPTION SMY-B40 at 16 dBm	5.2.9	--		-30 -25	dBc dBc
9	Spurious at 64.999999 MHz 544.08 MHz 640.005 MHz 992.03 MHz 1024.02 MHz	5.2.10	-- -- -- -- --		-70 -70 -70 -70 -70	dBc dBc dBc dBc dBc
10	SSB phase noise at 20 kHz from carrier at 64 MHz 100 MHz 779 MHz 1040 MHz 2080 MHz for SMY02 SMY43 only: 894 MHz at 45 kHz from carrier 894 MHz at 300 kHz from carrier 1990 MHz at 600 kHz from carrier	5.2.11	-- -- -- -- -- -- -- -- --		-114 -132 -114 -114 -108 -126 -138 -138	dBc dBc dBc dBc dBc dBc dBc dBc
11	Broadband noise $f \geq 65$ MHz $f < 65$ MHz	5.2.12	-- --		-140 -135	dBc dBc

Item	Characteristic	Measure as in section	Min	Actual	Max	Unit	
12	Residual FM, CCITT, RMS 520 MHz < f < 1040 MHz	5.2.13	--		10	Hz	
	Residual FM (30 Hz to 20 kHz) 1040 MHz < f < 2080 MHz		--		20	Hz	
13	AF Synthesizer Level error at 1 kHz	5.2.14	--		1	%	
	Frequency error		--		$5 \cdot 10^{-5}$		
14	AF synthesizer distortion at 1 kHz	5.2.14	--		0.1	%	
15	Ext. modulation voltage window	5.2.15	0.97		1.03	V <sub>eff</sub>	
16	AM modulation depth without opt. SMY-B40	5.2.16					
	at 1 MHz m = 30 %		27,8		32,2	%	
	m = 80 %		75,8		84,2	%	
	10 MHz m = 30 %		27,8		32,2	%	
	m = 80 %		75,8		84,2	%	
	100 MHz m = 30 %		27,8		32,2	%	
	m = 80 %		75,8		84,2	%	
	1000 MHz m = 30 %		27,8		32,2	%	
	m = 80 %		75,8		84,2	%	
	with opt. SMY-B40						
	bei 1 MHz m = 30 %		25,8		34,2	%	
	m = 80 %		73,8		86,2	%	
	10 MHz m = 30 %		25,8		34,2	%	
	m = 80 %		73,8		86,2	%	
100 MHz m = 30 %	25,8		34,2	%			
m = 80 %	73,8		86,2	%			
1000 MHz m = 30 %	25,8		34,2	%			
m = 80 %	73,8		86,2	%			
17	AM distortion f <sub>mod</sub> = 1 kHz m = 30%	5.2.17					
	at 1 MHz with opt. SMY-B40		--		3	%	
	without opt. SMY-B40		--		1	%	
	10 MHz		--		1	%	
	100 MHz		--		1	%	
	1000 MHz		--		1	%	
	m = 80%						
	at 1 MHz with opt. SMY-B40		--		5	%	
	without opt. SMY-B40		--		2	%	
	10 MHz		--		2	%	
100 MHz	--		2	%			
1000 MHz	--		2	%			
18	AM frequency response	5.2.18					
	up to 10 kHz		--		0.4	dB	
	up to 50 kHz	--		3	dB		

Item	Characteristic	Measure as in section	Min	Actual	Max	Unit	
19	Incidental $\phi$ M at 30% AM f > 1040 MHz (for SMY02)	5.2.21	--		0.2	rad	
			--		0.4	rad	
20	FM deviation setting	5.2.22					
			at 1 kHz	0.97		1.03	kHz
			3 kHz	2.91		3.09	kHz
			10 kHz	9.7		10.3	kHz
			30 kHz	29.1		30.9	kHz
	100 kHz	97		103	kHz		
21	FM distortion	5.2.23	--		0.3	%	
22	FM frequency response	5.2.24					
			20 Hz to 100 kHz	--		0.5	dB
	10 Hz to 2 MHz				3.0	dB	
23	Stereo modulation	5.2.26					
			Cross-talk attenuation	50		--	dB
			Signal-to-noise ratio	70		--	dB
			Unweighted signal-to-noise ratio	76		--	dB
	Distortion		0.3		--	%	
24	PM deviation	5.2.27	--		1	rad	
25	PM distortion	5.2.28	--		0.5	%	
26	Modulation frequency response 20 Hz to 20 kHz	5.2.29	--		3	dB	
27	Response treshold of overvoltage protection without OPTION SMY-B40	5.2.31					
			with SMY01				
			for HF	0.5		1.1	W
			for DC	5		7	V
			with SMY02				
			for HF	0.3		0.7	W
for DC	5		7	V			
	with OPTION SMY-B40	5.2.30					
	for HF		1		2	W	
	for DC		7,5		8,5	V	
28	Pulse modulation with OPTION SMY-B40	5.2.32					
			ON/OFF-ratio				
			at f = 70 MHz	70		-	dBc
			at f = 520 MHz	65		-	dBc
			at f = 800 MHz	65		-	dBc
			at f = 2080 MHz	35		-	dBc
			rise time	-		20	ns
fall time	-		20	ns			
	pulse delay time		-	200	ns		
29	Pulse modulation without OPTION SMY-B40	5.2.33					
			ON/OFF-ratio	80		-	dBc
			rise time	-		typ. 4	$\mu$ s
			fall time	-		typ. 4	$\mu$ s
	delay-time		-	typ. 3.5	$\mu$ s		

# Index

## A

Adaption of the power supply.....	1.1
Addressed commands .....	3.19
AF INT output .....	2.2; 2.12
ALC bandwidth .....	2.13
AM	
DC .....	5.11
distortion.....	5.11
frequency response .....	5.11
AM EXT input .....	2.2; 2.18
Amplitude	
display .....	2.7
modulation.....	2.13
ASCII/ISO and IEC character set.....	3.20
Attention line	
HIGH .....	3.2
LOW .....	3.19

## B

BLANK.....	2.3; 2.15
Broadband noise.....	5.9

## C

Calibration .....	4.1
Changing	
modes (local/remote) .....	3.28
parameter units .....	2.6
Character set, ASCII/ISO and IEC.....	3.20
Cleaning the exterior of the instrument .....	4.1
Command processing (IEC-bus).....	3.26
Common Commands .....	3.9
Common Queries.....	3.10
Correcting an entry .....	2.6

## D

DATA ENTER/UNITS keypad.....	2.2; 2.5
Data request.....	3.15
Data request commands	
device-independent .....	3.10
device-specific.....	3.6
for error handling .....	3.27
syntax.....	3.12
Deviation	
FM.....	2.15
PM.....	2.17
Device functions, resetting.....	3.28
Device messages	
device-independent data request commands .....	3.10
device-independent setting commands.....	3.9
device-specific data request commands.....	3.6
device-specific setting commands .....	3.2
notation .....	3.2; 3.17
syntax: controller to SMY.....	3.12
syntax: SMY to controller.....	3.15
Display	
AMPLITUDE.....	2.7
FREQUENCY.....	2.7
MODULATION .....	2.7
testing the.....	5.2
Displaying active special functions .....	2.24

## E

Error handling (IEC-bus) .....	3.27
ERRORS? (device-specific data request commands) ..	3.27
ESE .....	3.23
ESR .....	3.22
Event status enable register.....	3.23
Event status register .....	3.22
Exchanging the power fuse .....	1.1
External reference.....	2.9

## F

FM	
deviation setting.....	5.12
distortion .....	5.12
frequency response .....	5.12
FM/φM EXT input.....	2.2; 2.18
Frequency	
accuracy .....	5.2
display .....	2.7
modulation .....	2.15
Frequency (RF).....	2.10
Front view .....	2.2
Function errors.....	2.8

## H

Harmonic level .....	5.6
HIGH indication in the modulation display .....	2.18

## I

IEC-bus	
address.....	2.9; 2.31; 3.1
bus lines .....	3.30
command processing.....	3.26
connector.....	3.30
error handling.....	3.27
synchronization .....	3.26
Incidental AM at FM.....	5.13
Incidental φM at AM.....	5.12
Input	
AM EXT .....	2.2; 2.18
BLANK.....	2.3; 2.15
errors .....	2.8
FM/φM EXT .....	2.2; 2.18
resistance .....	2.18
SEQ.....	2.3; 2.23
Installing option SMY-B1 .....	1.2
Installing option SMY-B40.....	1.3
Instrument preset .....	2.8
Instrument settings	
recalling .....	2.8; 2.22; 2.23
storing.....	2.8; 2.22
Interface	
functions .....	3.29
messages .....	3.19
Internal	
AF modulation frequency .....	2.12
reference .....	2.9



# Index

## A

Adaption of the power supply.....	1.1
Addressed commands .....	3.19
AF INT output .....	2.2; 2.12
ALC bandwidth .....	2.13
AM	
DC.....	5.11
distortion.....	5.11
frequency response.....	5.11
AM EXT input .....	2.2; 2.18
Amplitude	
display.....	2.7
modulation.....	2.13
ASCII/ISO and IEC character set.....	3.20
Attention line	
HIGH.....	3.2
LOW.....	3.19

## B

BLANK.....	2.3; 2.15
Broadband noise.....	5.9

## C

Calibration .....	4.1
Changing	
modes (local/remote).....	3.28
parameter units .....	2.6
Character set, ASCII/ISO and IEC.....	3.20
Cleaning the exterior of the instrument .....	4.1
Command processing (IEC-bus).....	3.26
Common Commands.....	3.9
Common Queries.....	3.10
Correcting an entry.....	2.6

## D

DATA ENTER/UNITS keypad.....	2.2; 2.5
Data request.....	3.15
Data request commands	
device-independent .....	3.10
device-specific.....	3.6
for error handling .....	3.27
syntax.....	3.12
Deviation	
FM.....	2.15
PM.....	2.17
Device functions, resetting.....	3.28
Device messages	
device-independent data request commands .....	3.10
device-independent setting commands.....	3.9
device-specific data request commands.....	3.6
device-specific setting commands .....	3.2
notation .....	3.2; 3.17
syntax: controller to SMY.....	3.12
syntax: SMY to controller.....	3.15
Display	
AMPLITUDE.....	2.7
FREQUENCY.....	2.7
MODULATION .....	2.7
testing the.....	5.2
Displaying active special functions .....	2.24

## E

Error handling (IEC-bus) .....	3.27
ERRORS? (device-specific data request commands) ..	3.27
ESE .....	3.23
ESR .....	3.22
Event status enable register.....	3.23
Event status register .....	3.22
Exchanging the power fuse .....	1.1
External reference.....	2.9

## F

FM	
deviation setting.....	5.12
distortion.....	5.12
frequency response .....	5.12
FM/φM EXT input.....	2.2; 2.18
Frequency	
accuracy .....	5.2
display .....	2.7
modulation .....	2.15
Frequency (RF).....	2.10
Front view .....	2.2
Function errors.....	2.8

## H

Harmonic level .....	5.6
HIGH indication in the modulation display .....	2.18

## I

IEC-bus	
address.....	2.9; 2.31; 3.1
bus lines .....	3.30
command processing.....	3.26
connector.....	3.30
error handling.....	3.27
synchronization.....	3.26
Incidental AM at FM .....	5.13
Incidental φM at AM .....	5.12
Input	
AM EXT .....	2.2; 2.18
BLANK.....	2.3; 2.15
errors .....	2.8
FM/φM EXT .....	2.2; 2.18
resistance .....	2.18
SEQ.....	2.3; 2.23
Installing option SMY-B1 .....	1.2
Installing option SMY-B40.....	1.3
Instrument preset .....	2.8
Instrument settings	
recalling .....	2.8; 2.22; 2.23
storing.....	2.8; 2.22
Interface	
functions .....	3.29
messages .....	3.19
Internal	
AF modulation frequency .....	2.12
reference .....	2.9

<b>Status</b>	
byte .....	3.23
codes .....	2.27; 2.28; 2.29
messages .....	2.8; 2.27
register .....	3.21; 3.22; 3.23
<b>STATUS LED and key</b> .....	2.2; 2.8; 2.24
<b>STB</b> .....	3.23
<b>STEP</b> .....	2.4; 2.20
<b>Step size of a parameter</b> .....	2.20
<b>STO (Store)</b> .....	2.2; 2.22
<b>Storage</b> .....	4.1
<b>Storage temperature range</b> .....	4.1
<b>Store - recall</b> .....	2.8
<b>Sweep</b> .....	2.21
<b>Synchronization (IEC-bus)</b> .....	3.26
<b>Syntax of device messages</b>	
from controller to SMY .....	3.12
from SMY to controller .....	3.15

<b>T</b>	
Two-tone modulation .....	2.18

<b>U</b>	
Universal commands .....	3.19

<b>V</b>	
Variation .....	2.8; 2.19

<b>Z</b>	
ZZA-93 .....	1.1